

Destaco Portfolio of Products

A Comprehensive Offering of High-Performance Products



Built on a Strong Foundation



Destaco, a Dover company, is a global leader in the design and manufacture of high-performance automation, workholding and remote-handling solutions. The company serves customers in a variety of end-markets, including the automotive, life sciences, consumer packaged goods, aerospace, industrial and nuclear sectors.

Built on a legacy of more than 100 years, Destaco offers a comprehensive portfolio of products designed to engineer precise movement, placement and control solutions that drive productivity and uptime for manufacturers around the world. The Destaco family of products consists of industry-leading brands such as Destaco Manual Clamps, Power Clamps, and End Effectors; CAMCO™ and Ferguson™ Indexers; Robohand™ Grippers; and CRL™ Manipulators and Transfer Ports.

Destaco is based in Auburn Hills, Michigan, U.S.A. The company has more than 800 employees with 13 locations, in 9 countries, across the Americas, Europe and Asia.

Destaco is part of Dover Corporation, a diversified global manufacturer with annual revenues of \$7 billion. The company delivers innovative equipment and components, specialty systems and support services through four major operating segments: Energy, Engineered Systems, Fluids, and Refrigeration & Food Equipment. Headquartered in Downers Grove, IL, (NYSE: DOV)

More information is available at destaco.com and dovercorporation.com

Focusing all of our Resources

New Product Development

Destaco has dedicated resources to design and build the next generation of products and solutions

Customer and Technical Service

Destaco has industry leading global support to address any product and application concerns you may have

Design Tools

Destaco provides an extensive CAD library, sizing software, and online tools to support our global customers



Our Insight Working for You

Application Engineering

We utilize our expertise and complete portfolio of products to create solution that fit our customers' needs and applications

Custom Solutions

If our off-the-shelf solutions don't fit, we will partner with our customers to develop products that will



When an off-the-shelf product can't handle it - we can!

With many years of experience working with OEM machine builders, we can make our product fit your unique application. We will partner with you to design the right product for your application – from altering an existing product to building a completely new product, we have the experience and expertise to help your project succeed.

Using our expertise to develop custom solutions for unique applications, Destaco helps you save time and resources, allowing you to focus on your core business and gain a competitive advantage in the marketplace.

- Proven quality from the experts
- Reduce risk by using our experienced engineers
- Easy reordering with unique part numbers
- Simplify your supply chain
- Three levels of customization from simple alterations to complex custom products



End Effector Solutions

Speed Matters

Destaco end effectors are designed to help you move parts faster in today's production line by using high strength, lightweight aluminum modular components, durable vacuum cups and the fastest venturis on the market.

Markets



Applications



Grippers, Rotaries, and Linear Slide Solutions

Engineered Reliability

Destaco's Robohand products are engineered for reliability and long life to ensure maximum production uptime. These products are designed and machined for precise repeatability with minimal maintenance.

Markets

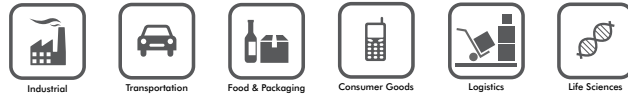

Applications



Rotary Indexers and Conveyor Solutions

Smarter Precision Indexing

Destaco's CAMCO products have been the industry standard for the highest quality cam-actuated motion control products available. Destaco manufactures a wide range of motion control products including indexing drives, linear and rotary parts handlers, precision link conveyors, magnetically-propelled conveyors, servo-mechanical drives, and custom cams

Markets



Applications



Manual and Pneumatic Clamping Solutions

Designed to Hold Securely

Destaco manual and pneumatic light-duty clamps are built to last for years of service, and designed to keep your workpieces in place. Manual and light-duty clamps are offered in a wide variety of styles to hold a part securely in place during an application.

Markets



Applications

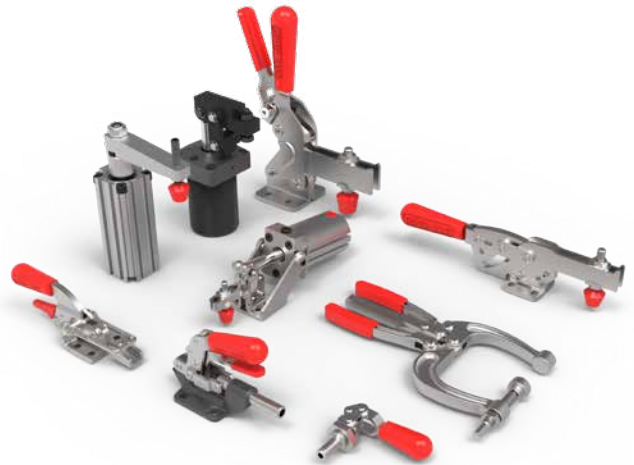
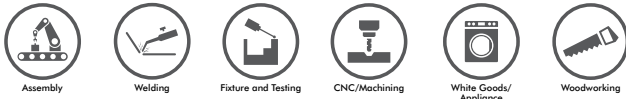

Power Clamping and Pivot Solutions

Clamp with Confidence

Destaco power clamping products range from heavy-duty sealed clamps for welding environments, to compact light-duty clamps for a variety of clamping applications. Pin clamps and pivot units are used in locating and positioning applications. All of these products offer exceptional clamping forces, holding capacities, and durability.

Markets



Applications

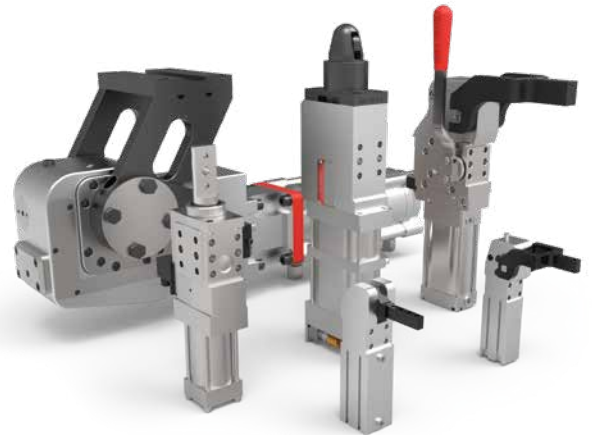

Remote Handling and Containment Solutions

Clean. Safe. Flexible.

Destaco's Central Research Laboratories (CRL) rapid transfer ports, gloveport systems and telemanipulators allow human operators to safely perform dexterous maneuvers in hazardous or sterile environments. Destaco's CRL products are designed for safe and efficient handling of materials where the human operator cannot have direct contact.

Markets



Applications



Tool Changers

Automatic and Manual

- Lightweight to heavy payload solutions
- Multiple styles of tool changers to choose from
- Variety of air, electric and vacuum utilities supported
- Advanced locking mechanism to minimize deflection after coupling



Accelerate® Collection and Round Tooling

Lightweight and Traditional Round Tooling Components

- Lightweight crossbar, saddle, and tri-axis solutions
- Lightweight aluminum modular components
- World tool aluminum standard and tapered booms
- Metric and imperial tubes and components



BodyBuilder™ Tooling System

Octagonal Booms and Components

- Multiple sizes of octagonal structures offers strength and stability
- Off the shelf, ready to assemble mounts and accessories
- Patented alignment system allows quick setup after replacement
- Accessories can be mounted and repositioned quickly and easily



SpiderGrip Tooling System

Precision Geometric Booms and Components

- Booms and components in standard metric sizes
- High strength-to-weight ratio aluminum
- Patented engineered break-away anchors and collars
- Automatic optical and CMM validation points



Vacuum Products

Vacuum Cups and Vacuum Generators

- Standard and high temperature vacuum cups
- ARV® auto release venturi and vacuum generators
- Spring loaded cup mounts and double blank detectors
- EcoCup™ - The world's first electric vacuum cup



Parallel Grippers

Pneumatic and Electric

- Cost effective OEM machine builder gripping solutions
- Discrete open/close control electric gripping solutions
- Pneumatic 2-jaw and 3-jaw gripping solutions
- Clean room, precision, harsh environment and gantry system solutions



Angular Grippers

Toggle-Lock and Cam-Driven

- Cost effective cam-driven compact gripping solutions
- 180 degree opening angles for in-line conveying systems
- Harsh environments support with spring assist shielded designs
- High temperature applications using Viton® seals



Rotaries

Flange and Shaft Output

- Space saving low-profile designs ideal for OEM machines
- Precise positioning with zero backlash rotation
- Pass-thru air utility with rotary manifold option
- Supports small to very large payloads

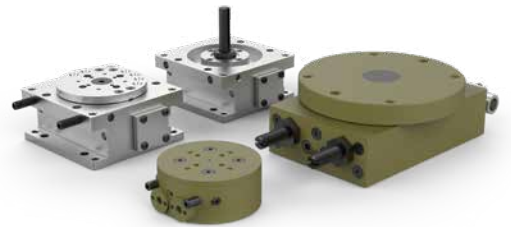

Linear Slides

Base, Ball-Rail, and Thrusters

- Multiple styles to extend, retract, push or pull applications
- Modular system supports multiple linear movements and positioning
- Air transfer to tooling simplified with telescopic airlines
- Linear solutions for machining, automation and harsh environment pick-and-place applications



Sheet Metal Grippers

Toggle-Lock and Cam-Actuated Grippers

- Press shop and sheet metal transfer application solutions
- Increase productivity with lightweight, high speed Accelerate® grippers
- Wide variety of mounting, jaw and tip configurations offered
- Long term reliability with minimal maintenance



Servo Positioners

Double Contact Barrel, Roller Gear and Parallel Cam

- Large payload capacity in compact housing
- Lubricated for life for minimal wear
- Smooth operation using a precision engineered roller cam and designs
- Large opening through the center of the output flange



Servo-Mechanical Dial Drives

Medium and Heavy Duty

- Zero backlash for precision indexing
- Maintenance-free mechanical and servo-based indexers
- Rotary index drives offers robust superior load capabilities
- Offered with several motor manufactures and optional output overload clutches



Mechanical Index Drives

Right Angle and Parallel Shaft/Flange

- Fixed center distance between input and output shafts
- Smooth acceleration and deceleration with precise positioning
- Some index drive models offer universal mounting on any side
- Many different motion profiles available as standard, custom motions available upon request



Conveyors

Modular Table-Top, Heavy-Duty and Magnet-Propelled

- Precision positioning for assembly and manufacturing
- Combines excellent accuracy and high load capacities
- Can be configured in a carousel or over-under style
- Standard modules for flexible lengths, heights or shapes



Custom Cams

Design and Manufacturing Services

- Backed by 100 years of experience
- Comprehensive range of configurations, tolerances and materials
- Precise, economical and engineered for your exacting specifications
- Alternative to "in-house" design, engineering and manufacturing



Manual Hold Down Clamps

Vertical and Horizontal Handle

- Heavy-duty and stainless steel models available
- Pneumatic versions available for select models
- Base, flange and weld mounting.
- Destaco® Toggle Lock Plus available on select models



Push and Pull Action Clamps

Plunger and Latch(hook)

- Threaded body for through-hole or tapped-hole mounting (Plunger)
- Heavy duty and square plunger models available (Plunger)
- J-hooks and U-hooks are threaded for easy adjustment (Latch)
- Safe, single-handed operation (Latch)



Squeeze Action Clamps

Standard Plier and Weldable

- Forged alloy steel construction for high strength
- Two-way trigger release for fast and easy opening
- Different jaw styles for use with parts of great thickness and depths
- Stainless steel model available

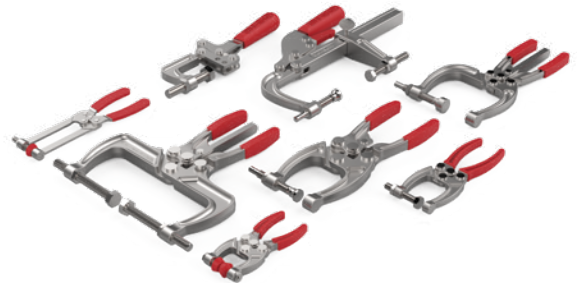

Light Duty Clamping

Pneumatic Swing and Lever Clamps

- Several body styles, arms, and mounting accessories available
- Threaded body style available for through-hole mounting
- 8700 Series features a clamp arm swinging up and out of the way
- 9500 Series clamp arm has no vertical travel during 90° swing



Power Solutions

Pneumatic Power Cylinders and Hydraulic Solutions.

- Power cylinders produce a 10:1 Mechanical Advantage
- Power cylinder are available in round and rectangular designs
- Hydraulic products include threaded body cylinders, swing/pull clamps, through-hole rams and power boosters.



Enclosed Power Clamps

Pneumatic and Manual

- TCC and 82M series offers complete family of power clamps
- Clamps sizes range from 12mm diameter cylinder bore to 80mm
- Several clamp arm types and arm opening angles are available
- Tolerance Compensation and Cylinder with hold open device available

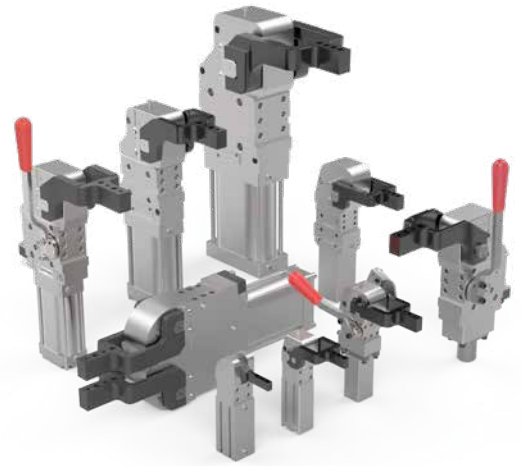

Pneumatic Pin Clamps

Hook Pin and Tolerance Compensating

- Sealed and protected against contaminants
- Self-locking mechanism in clamping position
- Consistent clamping force throughout clamping range
- Different hook sizes and centering pins available



Pin Packages

Manual and Pneumatic Single Pin, Double Pin

- Compact, low-weight design
- High accuracy of positioning
- Lateral and front-facing mounting surfaces
- Optional piston rod cover, anti-rotate device and external guide



Pivot Units

Pneumatic and Electric

- Versatile mounting allows vertical and horizontal positions
- Multiple saddle arm opening angles and orientations available
- Electric version allows variable swivel angle over 205° degrees
- Electric version features constant torque with controlled acceleration/deceleration

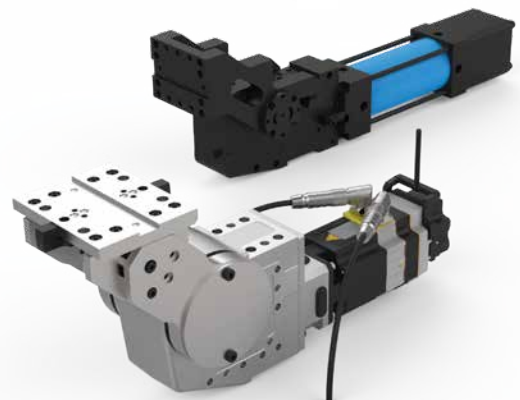

Gloveport Systems

Fixed and Push Through

- Fixed & push through glove ports
- Oval & round glove sleeve systems
- Custom glove port solutions
- Compatible with most commercially available gloves



Rapid Transfer Ports

Sterilizable Rapid Transfer, Liquid Transfer and Beta Accessories

- Rapid repeatable transfers without breaking containment
- Mechanical interlocks to prevent improper port operation
- 316 stainless steel alpha flange with stainless or polypropylene port door
- Custom and standard beta solutions, including containers, flanges and couplers



Telemanipulators

One and Three-Piece Manipulators

- Sealed and unsealed options available for one and three-piece models
- Several grip handles, tong jaws and motion/tamper locks available
- Optional radiation shielding and booting available on all models
- Can be customized to your specified needs



Waste and Bulk Packaging Solutions

Waste Drum Transfer System

- Built-in safety interlocks eliminates accidental breach of containment
- Actuated docking for fast, safe drum connect/disconnect operation.
- Polyethylene beta drum liner capable of multiple filling cycles
- Bagless RTP transfer system eliminates breach of containment while improving ergonomic safety for the operator





GLOBAL LOCATIONS

NORTH AMERICA

Corporate Headquarters

Auburn Hills, Michigan
Toll Free: 1.888.DESTACO
Marketing: marketing@destaco.com

Global Technology Center

Auburn Hills, Michigan
Tel: 1.248.836.6700
Customer Service: customerservice@destaco.com

Mt. Juliet, Tennessee
Tel: 1.888.DESTACO
Customer Service: customerservice@destaco.com

Wheeling, Illinois
Tel: 1.800.645.5207
Customer Service: camco@destaco.com

Red Wing, Minnesota (Central Research Laboratories)
Tel: 651.385.2142
Customer Service: sales@centres.com

ASIA

Bangkok, Thailand
Tel: +66-2-326-0812
Customer Service: info@destaco.com

Shanghai, China
Tel: +86-21-6081-2888
Customer Service: china@destaco.com

Bangalore, India
Tel: +91-80-41123421-426
Customer Service: india@destaco.com

EUROPE

Oberursel, Germany
Tel: +49-6171-705-0
Customer Service: europe@destaco.com

Sainte Florine, France
Tel: +33-4-73545001
Customer Service: france@destaco.com

Wolverhampton, United Kingdom
Tel: +44-1902-797980
Customer Service: uk@destaco.com

Sant Boi de Llobregat, Spain
Tel: +34-936361680
Customer Service: spain@destaco.com

Uithoorn, Netherlands
Tel: +31-297285332
Customer Service: benelux@destaco.com