

AMETEK[®]

Series 1025
Gemco[™]
Switches

Foot and Palm Operated Switches

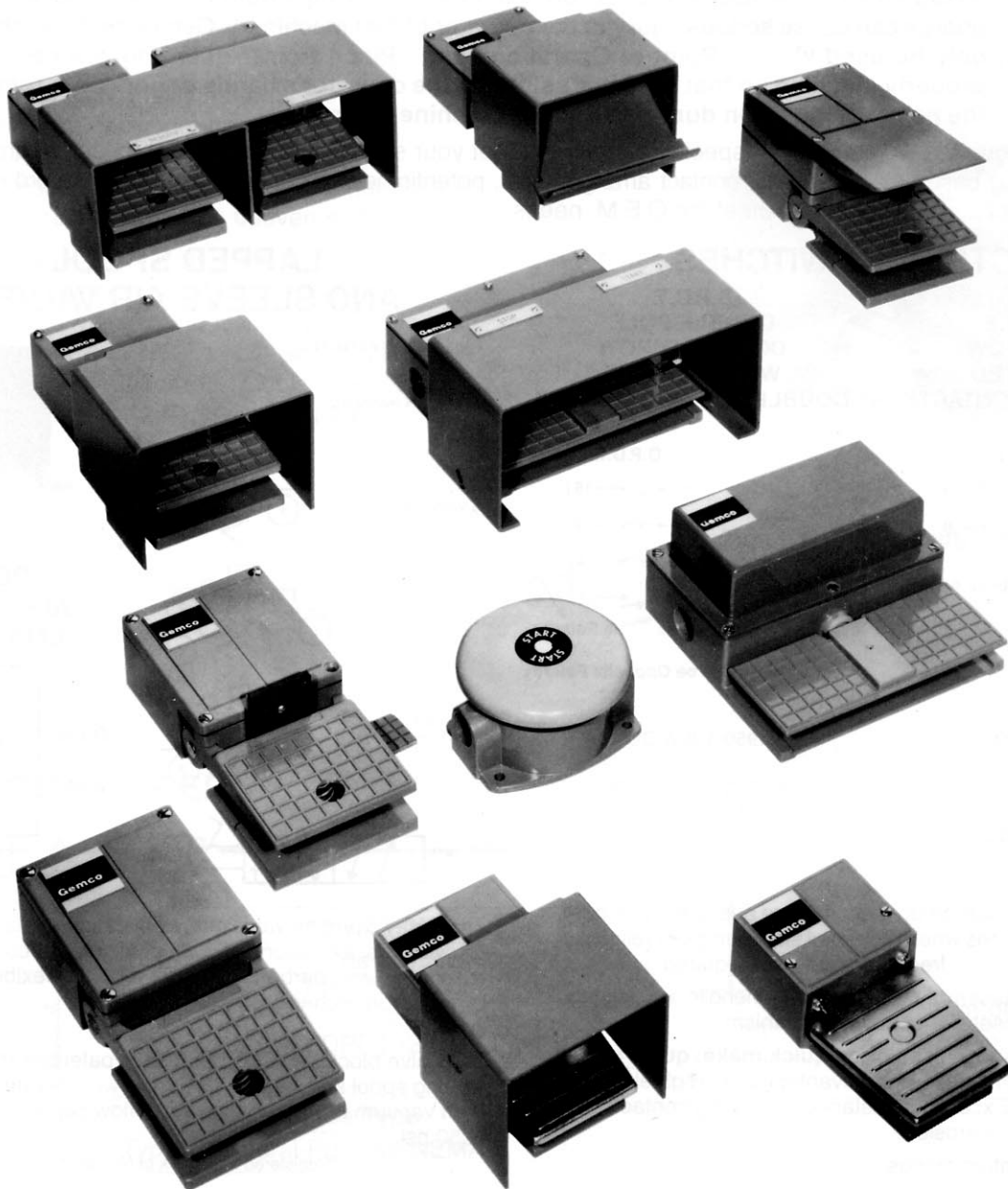

Foot and Palm Operated Switches

GEMCO'S FOOT AND PALM OPERATED SWITCHES are a part of a broad selection of industrial control devices. The four basic switches include:

- Type A — Standard Duty NEMA 1 Treadle Operator
- Type B — Heavy Duty NEMA 4 Treadle Operator
- Type C — Heavy Duty NEMA 4 Side Treadle Operator
- Type D — 5" Mushroom Button

These industrial-rated switches are especially suited to applications where an operator must have both hands free to perform other functions or, in the case of the Type D, where a highly visible switch is required for quick and easy operation. S.P.D.T. and/or D.P.D.T. contacts in each device are Gemco Precision Limit Switches.

Type A, B, C, and D Switches are available in a wide choice of contact arrangements, ratings and enclosure styles. Industrial duty 4 way 5 port air valves are available for air control circuits.

WARNING: Misapplication of foot switches on machinery lacking effective point-of-operation safeguards can cause serious injury to the operator of that machinery. Gemco foot switches should only be used where "Point of Operation" and "Pinch Point" guarding devices have been properly installed so that it is impossible for the operator's hands or fingers to remain within the point of operation during the actual machine cycle.

Gemco can provide a wide variety of special features to meet your specific requirements. Special guards, legend plates, mounting bases, paint finishes, contact arrangements, potentiometers, multiple pedal bases, cord sets, safety treadle gates, etc., are available to meet the O.E.M. needs.

ELECTRICAL SWITCHES

**S.P.D.T.
SINGLE POLE
DOUBLE THROW
WITH ISOLATED
DOUBLE BREAK CONTACTS**

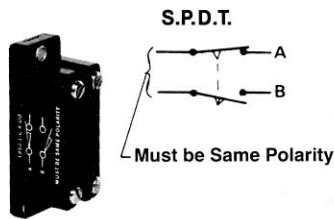

1950-1-B-A-DO

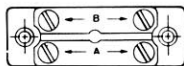

**D.P.D.T.
DOUBLE POLE
DOUBLE THROW
WITH ISOLATED
DOUBLE BREAK CONTACTS**

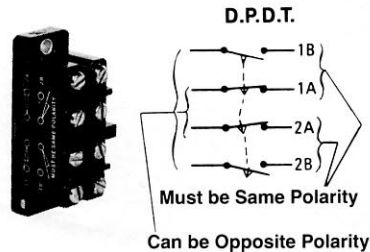

1950-4-B-A-DO

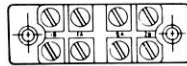

The Gemco Precision Snap Switches are designed for industrial duty applications where compact size, complete reliability and millions of trouble free operations are required.

Contact Block Assembly — a moulded phenolic housing that completely encloses the contact mechanism.

The welded silver cadmium oxide **quick make, quick break** contacts provide the following advantages: (1) High electrical conductivity, (2) Excellent resistance to sticking contacts, (3) Minimum electrical erosion.

See pg. 7 for contact ratings.

LAPPED SPOOL AND SLEEVE-AIR VALVES

MPL SYMBOLS

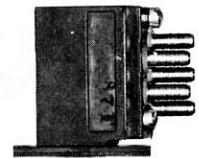
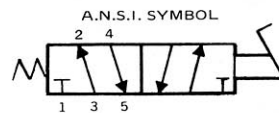
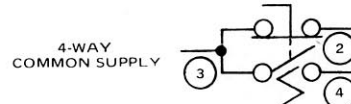
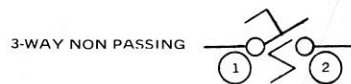

**4 WAY
5 PORT,
AIR VALVE
LM5-0107**

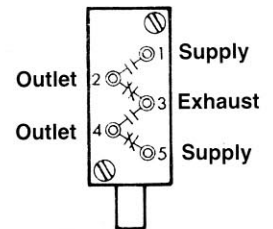

The 4 way 5 port air valve offers direct sequential operation of air cylinders, air motors, etc., or for air logic circuits. The valve is supplied with barbed fittings for 1/4" O.D. flexible tubing and is directly interchangeable with the spacing of one electrical switch.

The valve block uses the *Numatics patented stainless steel floating spool and sleeve. The valve will operate at pressures from vacuum to 150 psi. The valve flow capacity is 10 s.c.f.m. at 50 psi.

*Registered trademark of Numatics, Inc.

Foot and Palm Operated Switches

Type A STANDARD DUTY TREADLE OPERATED FOOT SWITCH

The Gemco Type A Standard Duty treadle operated two position spring return foot switch is an ideal device for general duty control applications, requiring either a S.P.D.T. or D.P.D.T., switch.

The treadle, formed of heavy gauge sheet metal, features a safety tread to reduce foot slippage and is available with or without a protective shield to prevent accidental treadle operation. An extension of the enclosing case projects beneath the treadle and serves a twofold purpose; it stabilizes the switch when not fastened down and prevents foreign objects from collecting under the treadle.

Constructed of high quality materials, the NEMA 1 die cast enclosure comes equipped with a 3/4 inch conduit entrance. Three mounting bosses in the enclosure base hold the switch firm when mounted on uneven surfaces.

For ease of wiring and piping, the precision switch contact block and valve manifold are mounted with terminals and fittings up. Single pole, double throw (1 NO - 1 NC) twin break silver contacts are standard. Double pole, double throw (2 NO - 2 NC), switches are optional.

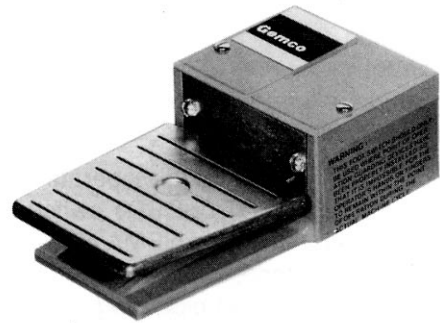

Type A NEMA 1 with Standard Cover

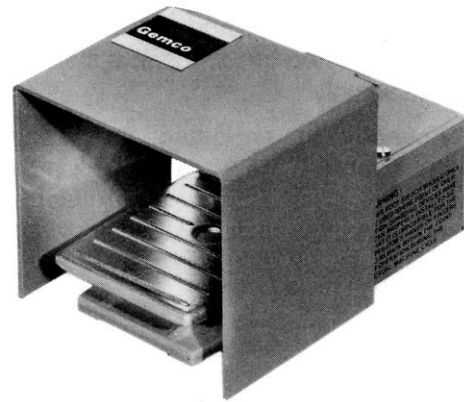

Type A NEMA 1 with Protective Shield

CATALOG NUMBER

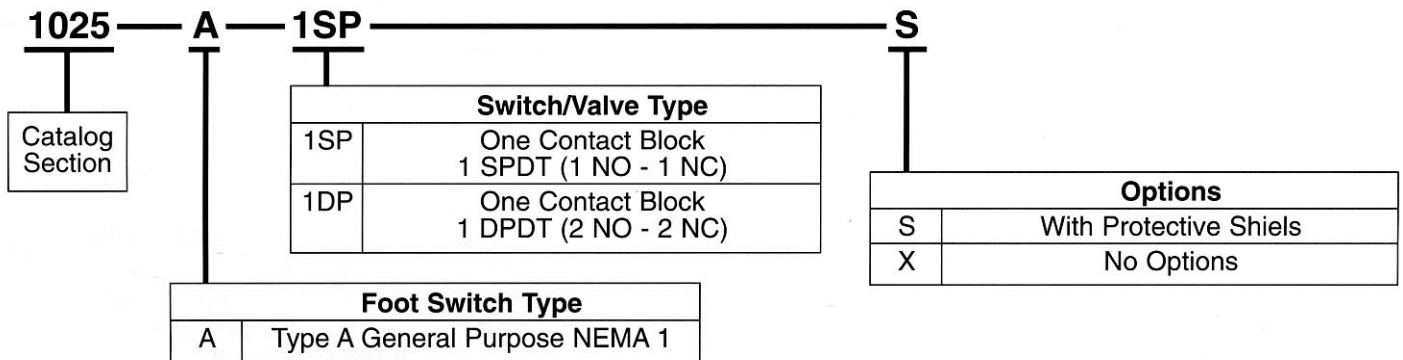

Warning: See Page 2

Foot and Palm Operated Switches

Type B HEAVY DUTY TREADLE OPERATED FOOT SWITCH

The Gemco Type B Standard Duty is designed for control circuit duty in industrial applications such as press brakes, welding machines or other production processes.

The basic switch is a treadle operated device with one or two SPDT or DPDT switches or a 4 way 5 port air valve, in a NEMA 4 enclosure. It is supplied with three holes for base mounting and a 3/4 inch tapered pipe tap for the conduit entrance. A grounding screw in the enclosure provides a convenient means of connecting a ground wire if required. When equipped with two contact blocks, both may be operated simultaneously or travel of the treadle can be adjusted to provide a tripping differential for two step or second stage operation. Treadle travel is adjusted by means of a stainless steel level assembly.

(A) housed in the enclosure. Allen head screws on the lever assembly shaft establish the amount of treadle travel required to actuate each of the contact blocks.

The Type B Heavy Duty foot switches are two or three position, spring return, front treadle operated. Pressure on the treadle closes the normally open contacts and release of the pressure returns the switch to the normally closed contacts. The lever assembly provides for adjustment of treadle travel to operate the contacts. When two contact blocks are supplied, adjustment of the lever assembly provides for simultaneous or differential tripping (second stage operation) of the contact blocks. The contact assembly, a precision unit switch, is fastened to the bottom of the case with the terminals up for easy wiring.

The NEMA Type 4 watertight and oiltight enclosure has a die cast case, cover, and treadle. A gasket between case and cover, and a friction type seal on the treadle shaft assure watertight and oiltight performance.

Four covers are available as standard - plain, guard, shield and shield with safety gate. Selection of the cover depends on the degree of protection desired to prevent accidental treadle operation.

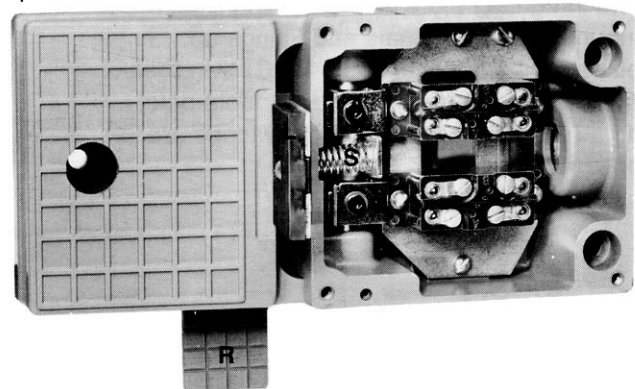

CATALOG NUMBER

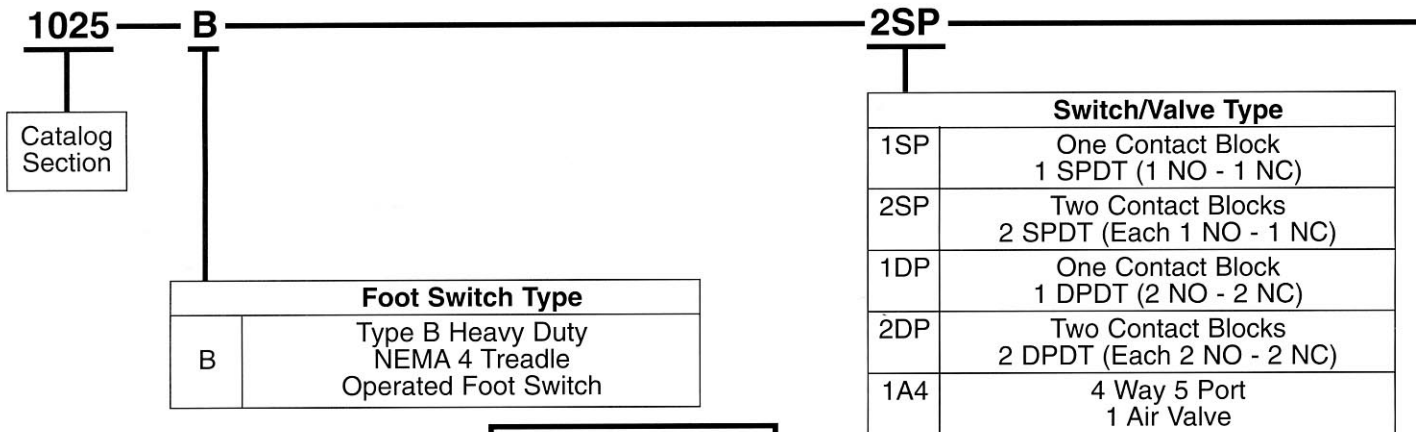

Warning: See Page 2

Foot and Palm Operated Switches



**NEMA 4 — Type B
With Plain Cover
And Treadle Latch**

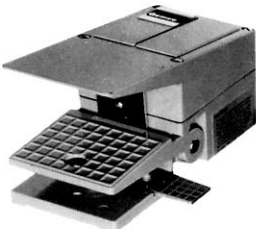

**NEMA 4 — Type B
With Guard
And Treadle Latch**



**NEMA 4 — Type B
With Shield
And Treadle Latch**

While Type B switches are normally spring-return, treadle latches (L) are available for conversion to maintained operation. Treadle latches, when supplied, permit spring return or maintained contacts operation. Half-down or full-down treadle latches are available to meet application requirements.

The “full down” latch engages and holds the treadle at the end of its travel. Both contact blocks or air valves are maintained in this position. The latch release pedal provides easy on-the-job conversion from maintained contacts to spring return. Depressing the red release pedal (R) frees the treadle from the latched position and allows the contacts or air valve to return to their normal positions. Conversion to spring return requires only a push down and forward motion on the latch release pedal to make the treadle latch inoperative. The latch release pedal is normally located on the right hand side, but it can be converted in the field to a left hand extension.

A safety spring within the enclosure assures treadle spring return should the main return spring under the treadle be damaged. All switches with second stage operation are factory assembled with a light spring. Medium and heavy springs are available if desired. The heavy second stage feel springs are not recommended for switches with treadle latches.



**NEMA 4 — Type B
With Plain Cover**



**NEMA 4 — Type B
With Guard**

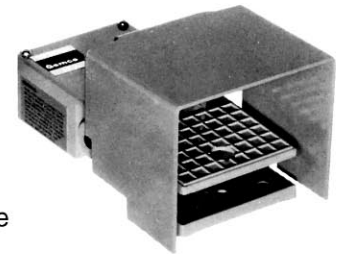

**NEMA 4 — Type B
With Shield**

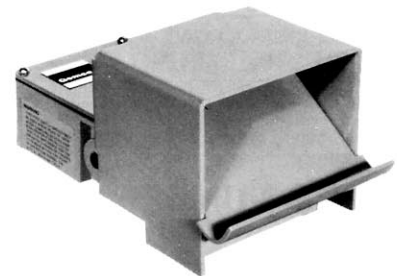

**NEMA 4 — Type B
With Shield and
Ultra Guard Safety Gate**

Cover Options	
P	Plain Cover, Covers Only the enclosure
G	Treadle Guard - provides top protection from accidental operation
S	Treadle Shield provides top and side protection
*U	Ultra Guard with Treadle Shield and Safety Gate which must be raised with the toe to gain access to the treadle
* Not available with treadle latch option	

Latch Option	
L	Treadle Latch Permit spring return or maintained contacts operation
X	No Latch

Warning: See Page 2

Foot and Palm Operated Switches

Type C HEAVY DUTY SIDE TREADLE OPERATED FOOT SWITCH

Type C Heavy Duty foot switches provide a mounting for two switches or two air valves mounted in the bottom of the case. Side treadle operated, in a manner comparable to a rocker type lever pivoted in the center, the treadle operates one contact block in one direction and the other contact block in the opposite direction. Designed for versatility, field adjustment may be made of treadle travel and for maintained or non-maintained contacts operations.

The switches are adjusted at the factory for spring return to the center "off" position from each direction. By simple rotation of a cam block, conversion may be made in the field to 2 maintained positions, one in each direction, or 3 maintained positions, one in each direction and the center "off" position, (see illustration). Treadle travel to operated the contacts can be adjusted and maintained by an Allen Head screw with a self-locking nut.

Available with or without a protective shield, the NEMA Type 4 watertight and oiltight enclosure has a die cast aluminum case, cover and treadle. There are two 3/4 inch pipe tapped conduit entrances, one of which is fitted with a pipe plug. A boss on the interior wall of the third side permits drilling and tapping a conduit entrance on the job, if required. A neoprene gasket between case and cover and a friction type seal on the treadle shaft assure watertight and oiltight performance.

Six nameplates, "START", "STOP", "FORWARD", "REVERSE", and two blanks for special marking are supplied with each switch.

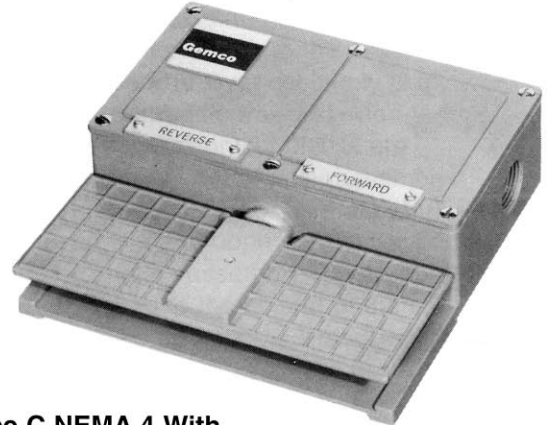

Type C NEMA 4 With Plain Cover

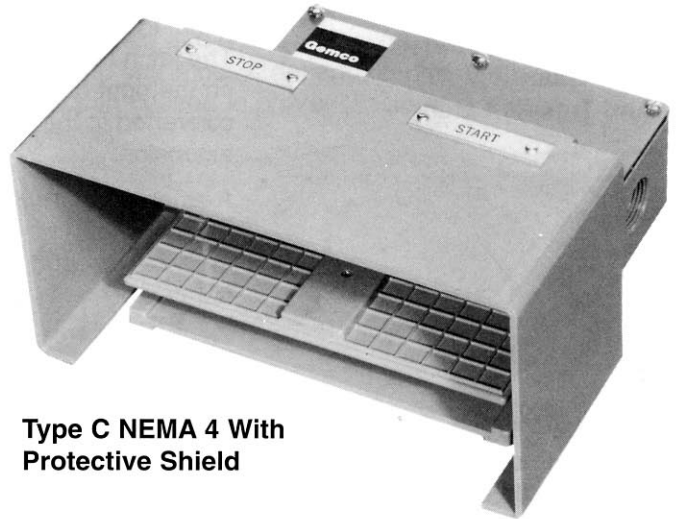

Type C NEMA 4 With Protective Shield

Left	Center	Right	2 Contact Blocks 3 Position — Field convertible to maintain left and right or maintained 3 Position.

1. Three Position, Spring Return
2. Two Position, Maintained Contact
3. Three Position, Maintained Contact
4. Blank Face

Nylon Cam

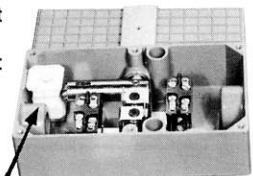

Type C with cover removed to show internal construction

CATALOG NUMBER

1025 — C — 2SP — S

Catalog Section

Switch/Valve Type	
2SP	Two Contact Blocks 2 SPDT (Each 1 NO - 1 NC)
2DP	Two Contact Blocks 2 DPDT (Each 2 NO - 2 NC)
2A4	4 Way 5 Port 2 Air Valves

Foot Switch Type	
C	Type C Heavy Duty NEMA 4 Side Treadle Operated NEMA 4 Foot Switch

Options	
S	With Protective Shields
X	No Options

Warning: See Page 2

Foot and Palm Operated Switches

Type D MUSHROOM BUTTON, FOOT OR PALM OPERATED SWITCH

Type D Mushroom Button foot or palm operated switch is particularly well suited for critical applications where a large, easy-to-see operator is required.

The Type D switch features a bright orange operating button 5 inches in diameter - ideal for an emergency stop station or where two switches are used as a safety measure to clear the operator's hands from a machine. The switch can be supplied with one or two SPDT or DPDT switches.

The NEMA Type 1 enclosure has a die cast case and operating button. There are two 3/4 inch pipe tapped conduit entrances, one of which is fitted with a pipe plug. Two conduit entrances are for those applications utilizing straight through wiring. For added resistance to the entrance of foreign materials, a neoprene billows type seal is a standard feature between the case and operating button.



The Type D Mushroom Button foot and palm operated switches contain 1 or 2 contact blocks, as selected, and these are mounted with terminals or manifold up for good accessibility. The operating button, which is the switch cover, is securely fastened to the enclosure by the indicating plate located in the center of the operating button. Removal of the nameplate and operating button provides access to the contact block assemblies.

CATALOG NUMBER

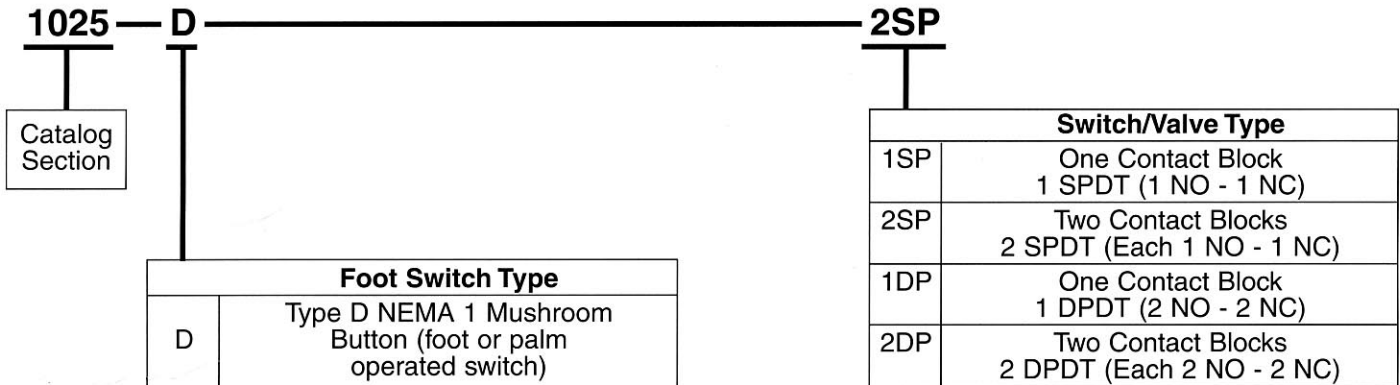

ELECTRICAL CONTACT RATINGS				
	Volts	A-C Pilot Duty		DC Pilot Duty
		Make Amps	Break Amps	
SPDT 1950-1-B-A- DO	115	40	15	0.25
	230	20	10	0.10
	440	10	6	
	600	8	5	
DPDT 1950-4-B-A- DO	115	30	3	0.20
	230	15	1.5	0.10
	440	7.5	0.75	
	600	6	0.6	

Part Number Cross Reference		
Switch Type	Cutler-Hammer Part Number	Gemco Part Number
A	10251-H25A	1025-A-1SP-X
C	10251-H26A	1025-C-2SP-X
D	10251-H28A	1025-D-1SP
D	10251-H31A	1025-D-2SP
B	10251-H33B	1025-B-1SP-P-X
B	10251-H34B	1025-B-1SP-G-X
B	10251-H34B	1025-B-1SP-G-X
B	10251-H35C	1025-B-1SP-S-X
B	10251-H40B	1025-B-2SP-G-X
B	10251-H41C	1025-B-2SP-S-X
B	10251-H42B	1025-B-2SP-P-L
B	10251-H43B	1025-B-2SP-G-L
B	10251-H44C	1025-B-sSP-S-L
B	10251-H47C	1025-1402
A	10251-H77A	1025-A-1SP-S

Warning: See Page 2

Type A, B, C and D—Foot Switches

APPROXIMATE DIMENSIONS AND SHIPPING WEIGHTS

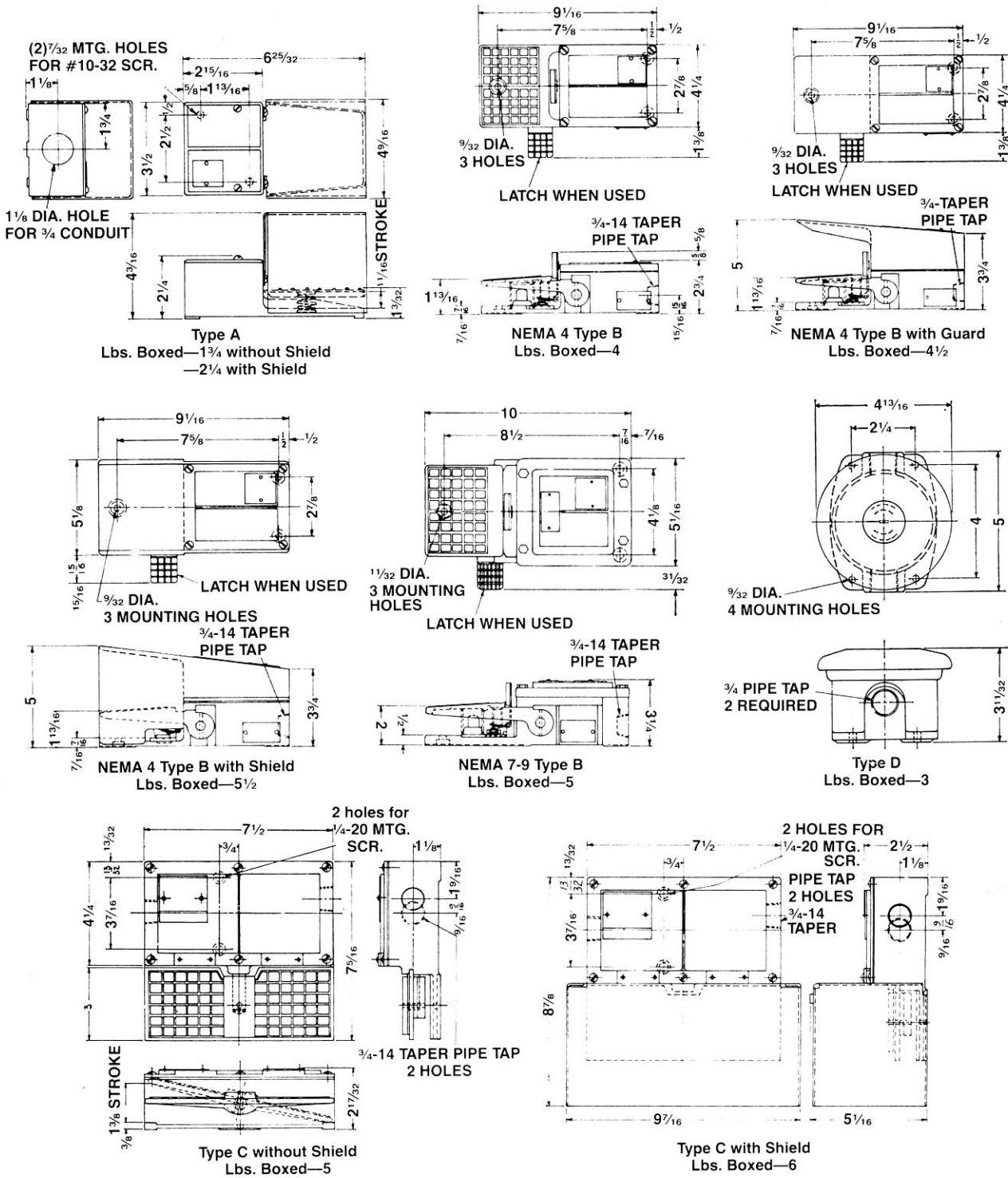

AMETEK[®]
 AUTOMATION & PROCESS TECHNOLOGIES

1080 NORTH CROOKS ROAD • CLAWSON, MI 48017 USA
 800-635-0289 • 248-435-0700 • Fax 248-435-8120
 www.ametekapt.com • www.ametek.com

1025.B1R
 11/01 • Z17
 1M