



canfield  
connector

Molded Multi-Pin for Sensors and Automation

M8 & M12

**CANFast**<sup>®</sup>  
round connectors  
&  
patch cords



***Making connections that last!***

1-800-554-5071

canfieldconnector.com

[www.mfcp.com](http://www.mfcp.com)

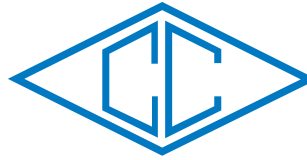

# canfield connector

## Quality is our goal.

Canfield Connector is a manufacturer of interconnection devices, electronic timers, modules and specialty electronic devices targeted at the fluid power industry. Our *Complete Quality Control Program* (CQCP) protects our customers by assuring them of 100% test and inspection prior to shipment of all items produced at Canfield Connector. Most items are tested during the manufacturing process and again during final inspection, making our products double or triple tested for function prior to shipment. Our Quality Policy at Canfield Industries is: Total Customer Satisfaction Through Unmatched Quality, Products, Service, and Integrity. Our Quality Objectives are Customer Satisfaction, On-Time Delivery, Sales and Profit Growth, High Quality Products, and Superior Supplier Performance. Canfield Connector operations have been certified to the ISO 9001 With Design International Quality System Standard.

## 1 year warranty

All products manufactured by Canfield Connector are warranted by Canfield Connector to be free of defects in material and workmanship for a period of one year from the purchase date. Canfield Connector's obligation under this warranty is limited to repair or replacement of the defective product or refund of the purchase price paid solely at the discretion of Canfield Connector and provided such defective product is returned to Canfield Connector freight prepaid and upon examination by Canfield Connector such product is found defective. This warranty shall be void in the event that the product has been subject to misuse, misapplication, improper maintenance, or tampering. This warranty is expressed in lieu of all other warranties, expressed or implied from Canfield Connector representatives or employees.

## Designs and published data

All designs and specifications are subject to change without notice. Such changes are not to be considered retroactive, and seller assumes no responsibility for revision of models already in the field. All data is sufficiently accurate for general use, but seller assumes no responsibility for errors or omissions. Certified prints are available on request, at a reasonable charge.



## Technical assistance

Our trained technical staff is available to help you with your questions concerning Canfield products. All questions are welcome. We are constantly developing new product lines and custom products for different applications. Ask our sales representative for more details. Call: (330) 758-8299 or 1-800-554-5071 Email: customerservice@canfieldconnector.com

## Ordering made easy

Our friendly Customer Service Team is available to take your order 8:00 AM to 5:00 PM EST Monday through Friday.

Call: (330)758-8299 or Toll Free: 1-800-554-5071

Fax: (330)758-8912

Email: customerservice@canfieldconnector.com



Youngstown, Ohio U.S.A.

### ***\*DISCLAIMER\****

***Product changes including specifications, features, designs, and availability are subject to change anytime without notice. For critical dimensions or specifications, contact factory.***

Canfield Industries, Inc.



ISO 9001:2015  
with design  
Cert # 05.096.1



MADE IN USA

[www.canfieldconnector.com](http://www.canfieldconnector.com) ◆ [em: customerservice@canfieldconnector.com](mailto:customerservice@canfieldconnector.com) ◆ [ph: 1-800-554-5071](tel:1-800-554-5071)

[www.mfcp.com](http://www.mfcp.com)

# Canfield Connector

8510 Foxwood Court ● Youngstown, OH 44514

## STANDARD TERMS OF SALE AND RESTOCKING

### 1. GENERAL:

- a.) This contract contains the entire agreement between parties and supersedes any prior or contemporaneous oral or written agreements or communications between them relating to the subject matter hereof.
- b.) This contract may not be assigned, modified or cancelled without Seller's prior written consent, and any attempt to assign, modify or cancel it without consent shall be absolutely void.
- c.) No delay or omission to exercise any right, per or remedy accruing to Seller upon breach or default by Buyer under this contract shall impair any such right, power or remedy of Seller, or shall be construed as a waiver of any such breach or default. All waivers must be in writing.
- d.) In the event of any of the provisions hereof shall, for any reason, be held void or unenforceable, the remaining provisions shall remain in full force and effect and shall control.
- e.) Any provisions of this contract prohibited by law of any state shall as to said state, be ineffective to the extent of such prohibition without invalidating the remaining provisions of this contract.
- f.) This contract shall be governed by and construed in accordance with the laws of the State of Ohio, excluding however, Ohio law pertaining to conflicts of law.

### 2. SELLER'S LIMITED WARRANTY AND LIMITATIONS OF LIABILITIES:

All goods sold hereunder are warranted to be free from defects in material and workmanship for a period of one (1) year from the date of manufacture unless otherwise agreed upon in writing, and to conform to applicable specifications, drawings, blueprints and/or samples. These express warranties are in lieu of and exclude all other warranties, express or implied. Seller's sole obligation under these warranties shall be to issue credit, repair, or replace any item or part thereof which is proved to be other than as warranted; no allowance shall be made for any labor charges of Buyer for replacement of parts, adjustment or repairs, or any other work, unless such charges are authorized in advance by Seller. If goods are claimed to be defective in material or workmanship or not to conform to specifications, drawings, blueprints and/or samples, Seller upon notice promptly given will either examine the goods at their site, or issue shipping instructions for return to Seller (transportation costs prepaid by Buyer). In the event any goods are proved to be other than as warranted, transportation costs to and from Seller's plant will be borne by Seller and reimbursement or credit will be made for amounts so expended by Buyer. In particular, seller makes no warranty respecting the merchantability of the products or their suitability or fitness for any particular purpose or use or respecting infringement. These warranties shall not extend to any goods or parts thereof which have been subjected to misuse or neglect, damage by accident, rendered defective by reason of improper installation or by the performance of repairs or alterations outside of Seller's plant except when performed under Seller's specific authority. These warranties shall not apply to any goods or parts thereof furnished by Buyer or acquired from others at Buyer's request and/or to Buyer's specifications. BUYER SHALL NOT IN ANY EVENT BE ENTITLED TO, AND SELLER SHALL NOT BE LIABLE FOR INDIRECT, SPECIAL, INCIDENTAL OR CONSEQUENTIAL DAMAGES OF ANY NATURE INCLUDING, WITHOUT BEING LIMITED TO, LOSS OF PROFIT, LOSS OF DATA, LOSS OF USE, PROMOTIONAL OR MANUFACTURING EXPENSES, OVERHEAD, INJURY TO REPUTATION OR LOSS OF CUSTOMERS. BUYER'S RECOVERY FROM SELLER FOR ANY CLAIM SHALL NOT EXCEED BUYER'S PURCHASE PRICE FOR THE PRODUCTS IRRESPECTIVE OF THE NATURE OF THE CLAIM, WHETHER IN CONTRACT, TORT, WARRANTY, OR OTHERWISE.

### 3. PAYMENT:

- a.) Checks are accepted subject to collection and the date of collection shall be deemed the date of payment. Any check received from Buyer may be applied by Seller against any obligation owing by Buyer to Seller, under this or any other contract, regardless of any statement appearing on or referring to such check, without discharging Buyer's liability for any additional amounts owing by Buyer to Seller; and the acceptance by Seller of such check shall not constitute a waiver of Seller's right to pursue the collection of any remaining balance.
- b.) On any invoice not paid by maturity date (net thirty (30) days), Buyer shall pay interest from maturity to date of payment at the annual percentage rate of 18% (or such lower rate as may be the maximum allowable by law), together with Seller's costs of collection (including reasonable attorneys' fees).
- c.) Buyer agrees to pay the entire net amount of each invoice rendered by Seller pursuant to the terms of each such invoice without offset or deduction.
- d.) Prices for any undeliverable Products may be increased by Seller in the event of any increase in Seller's cost of supplies, raw materials, labor or services, or any increase in Seller's cost resulting from government action or other cause beyond Seller's control.

### 4. CREDIT:

Seller may in its sole discretion at any time and from time to time change the terms of Buyer's credit, require payment in cash before shipment of any or all of the Products specified herein, and/or require anticipated payment of any or all amounts due or to become due under this contract. If Seller believes in good faith that Buyer's ability to make payments called for by this contract is or may be impaired, Seller may cancel this contract or any remaining balance thereof, Buyer remaining liable to pay for any Products already shipped.

### 5. TAXES/FREIGHT:

Unless otherwise agreed in writing, the amount of all transportation charges from Seller's location and all taxes or other charges now or hereafter imposed by any government authority upon sale, purchase, resale, delivery, manufacture, production or possession of the Products specified herein, which may be paid by Seller or for which Seller may be liable, shall be paid to Seller by Buyer in addition to the purchase price of the Products.

### 6. ORDERS:

- a.) Each order for Products is subject to acceptance in writing by Seller.
- b.) Orders may not be cancelled or rescheduled after delivery by Seller to the carrier. In the event of allocation of Products, orders that are accepted by Seller will be accepted using a fair schedule method.
- c.) Special Orders - Special orders for items not normally stocked are non-cancelable and non-returnable.

### 7. DELIVERIES/TITLE:

- a.) All goods shall be packed in suitable containers for protection in shipment and storage. No special charges for packing or crating shall be made unless specifically listed as an additional and separate charge on Seller's quotation or acceptance of Buyer's order.
- b.) Subject to Seller's right of stoppage in transit, delivery of the Products to a carrier shall constitute delivery to Buyer, and risk of loss shall thereupon pass to Buyer; however, title shall remain in Seller until Buyer makes payment in full under contract. Products invoiced and held by Seller for any reason shall be at Buyer's risk and expense. Delivery route shall be the election of Seller unless specifically designated by Buyer.

- c.) Delivery of any installment of Products within 30 days after the date specified therefor shall constitute a timely delivery. Thereafter, delivery shall be deemed timely unless prior to shipment Seller has received written notice of cancellation. Delivery of a quantity which does not vary by more than 10% from the quantity specified therefor shall constitute full performance of such delivery. Delay in delivery of one installment shall entitle Buyer to cancel that installment only.
- d.) Should delivery of all or part of the Products specified herein (or any other obligation of Seller) be delayed by events beyond Seller's control, Seller's time for performance shall be extended by the period of delay, or Seller may, at its option, cancel this contract without liability, Buyer remaining liable for shipments already made. Sellers shall not be liable for any delays in or failures of delivery due to acts of God or public authority, labor disturbances, accidents, fires, floods, extreme weather conditions, failures of and delays by carriers, shortages of material, delays of a supplier due to causes beyond its control.
- e.) Buyer is deemed to have accepted the Products unless notice of rejection is given within a reasonable time, which is agreed to be within seven (7) days after receipt. Buyer waives any right to revoke acceptance thereafter.
- f.) No return of Products will be accepted by Seller without a return materials authorization number (RMA#), which will be issued in Seller's sole discretion. Returned Products must be in original shipping cartons, and must be freight prepaid. In the event any goods are proved to be other than as warranted, transportation costs to and from Seller's plant will be borne by Seller and reimbursement or credit will be made for amounts so expended by Buyer. Notice of defective Products must be made within seven (7) calendar days of receipt. A complete description regarding the nature of the defect must be included with all returned Products. All items not eligible for credit will be returned to Buyer, transportation collect.

### 8. SPECIFICATIONS AND DESIGNS:

- a.) Should Buyer request that changes be made in the specifications or design relating to any goods, delivery dates and schedules shall be revised accordingly, if necessary, and an equitable adjustment, upward or downward, shall be made in price in so far as warranted.
- b.) Any designs, tools, patterns, material, drawings, information or equipment furnished by Buyer, or any special tools made or acquired for the Buyer by the Seller which becomes Buyer's property, shall be used only in the production of the goods called for herein and not otherwise, unless by Buyer's written consent. Seller agrees to exercise reasonable care with respect to such property and equipment while in its possession and control, but shall not be responsible for loss or damage occurring without its fault or negligence or for ordinary wear and tear.

### 9. USE OF PRODUCTS:

- a.) If technical advice is offered or given in connection with the use of any Products it will be as an accommodation to Buyer and without charge and Seller shall have no responsibilities or liabilities whatsoever for the content or use of such advice.
- b.) Products sold by Seller are not designed for use in life support or nuclear applications. Seller's customers using or selling Products for use in life support or nuclear applications do so at their own risk, agree that Seller and the Manufacturer of Products are not liable, in whole or in part, for any claim or damage arising from such use, and agree to fully indemnify Seller and the Manufacturer from and against any and all damages, loss, cost, expense or liability arising out of or in connection with the use or performance of Products in life support or nuclear applications.
- c.) Should the Buyer notify the Seller that its order is placed under a prime contract with an agency of the United States Government, the following terms and conditions shall be incorporated into Seller's terms of sale in so far as the Buyer is required to incorporate such provisions in its purchase orders or subcontracts of terms in so far as applicable to the goods sold hereunder.
- d.) The following clause set forth or referred to in Sections 7 and 12 of the Armed Services Procurement Regulations are hereby incorporated by reference: Renegotiation Act (7-103.17 12-604), Nondiscrimination in Employment (7-103.18 12-802), Officials Not to Benefit (7-103.19), Buy American Act (7-104.3 6-104.5), Notice to the Government of Labor Disputes (7-104.4), Excess Profit (7-104.11), Military Security Requirements (7-104.12), Examination of Records (7-104.15), Convict Labor (7-104.17 12-203). In order to make the context of the above clauses applicable to these terms of sale, the word "Buyer" shall be substituted for the word "Government" and the word "Seller" shall be substituted for the word "contractor" whenever necessary.
- e.) Unless the design for the goods shall have been furnished by the Buyer to the Seller and used by the Seller in manufacturing the goods, Seller shall defend and save harmless the Buyer from any claim that any product or article sold to the Buyer hereunder in and of itself infringes any United States letters patent by reason of its sale or use/ provided Seller is notified in writing within ten (10) days after any such claim is made against the Buyer, and provided further that Seller is permitted to defend the same in Buyer's name if action be brought. If the product or article sold to the Buyer hereunder is manufactured by the Seller according to a design furnished by the Buyer, the Buyer will defend and save harmless the Seller from any claims of infringement of any United States Letters patent.

### 10. TOOLING:

Tool, die, and pattern charges, if any, are in addition to the price of the Goods and are due and payable upon completion of the tooling. All such tools, dies and patterns shall be and remain the property of Seller. Charges for tools, dies, and patterns do not convey to Buyer, title, ownership interest in, or rights to possession or removal, or prevent their use by Seller for other purchasers, except as otherwise expressly provided by Seller and Buyer in writing with reference to this provision.

### 11. INSTALLATION/TRAINING:

Buyer acknowledges that no installation, training or education is contracted for or purchased under terms of this contract unless specifically agreed in writing. In the event that Buyer receives any training from Seller with respect to the Products, then, in that event, such training is personal to the persons receiving such training, and Buyer acknowledges that any persons receiving such training may not be capable of operating the Products.

### 12. RESTOCKING POLICY:

Merchandise that is returned must be accompanied by pre-approved return materials authorization number (RMA#). Return authorizations will be approved by Canfield Connector. When materials are received, an inspection will be performed to determine if restocking charges are applicable. Material that does not have an authorization will be returned to the purchaser at their expense. RETURNED ITEMS MAY ENTAIL A RESTOCKING CHARGE. CONSULT FACTORY FOR EXACT RESTOCKING FEES. AS CHARGES MAY VARY DEPENDING ON THE AMOUNT OF SPECIALTY OF THE ITEMS BEING RETURNED. CUSTOM PARTS & "9-" NUMBERS ARE NON-RETURNABLE AND NON-REFUNDABLE (EXCEPT IN CASES OF WARRANTY)

## Table of Contents



### **MOLDED ROUND CONNECTORS**

- 5** M8 - 8mm Straight
- 7** M12 - 12mm Straight
- 9** M12 - 12mm 90°

### **RP MOLDED PATCH CORDS**

#### ***M8 to M8***

- 11** 8mm Male Straight to 8mm Male Straight
- 12** 8mm Male Straight to 8mm Female Straight
- 13** 8mm Female Straight to 8mm Female Straight

#### ***M12 to M12***

- 14** 12mm Male Straight to 12mm Male Straight
- 15** 12mm Male Straight to 12mm Female Straight
- 16** 12mm Female Straight to 12mm Female Straight
- 17** 12mm Male 90° to 12mm Male 90°
- 18** 12mm Male 90° to 12mm Female 90°
- 19** 12mm Female 90° to 12mm Female 90°
- 20** 12mm Male Straight to 12mm Male 90°
- 21** 12mm Male Straight to 12mm Female 90°
- 22** 12mm Male 90° to 12mm Female Straight
- 23** 12mm Female 90° to 12mm Female Straight

#### ***M8 to M12***

- 24** 8mm Male Straight to 12mm Female Straight
- 25** 8mm Male Straight to 12mm Female 90°

#### ***M12 to M8***

- 26** 12mm Male Straight to 8mm Male Straight
- 27** 12mm Male Straight to 8mm Female Straight
- 28** 12mm Female Straight to 8mm Female Straight
- 29** 12mm Male 90° to 8mm Male Straight
- 30** 12mm Male 90° to 8mm Female Straight
- 31** 12mm Female 90° to 8mm Female Straight





canfield  
connector

CANFast<sup>®</sup>  
round connectors

**M8 SERIES**  
8MM STRAIGHT  
MOLDED  
ROUND CONNECTORS

## GENERAL DESCRIPTION

Canfield Connector is known for its robust connections with an American twist, and the CANFAST<sup>®</sup> brand of M8 electrical connectors are no exception. This family of robust, all molded anti-vibration electrical connectors for sensors and actuators are specified by those needing a sure connection to valves, sensors, or automation of all types. Available in all industry styles including shielded and unshielded, and in various wire lengths. The CANFAST<sup>®</sup> round connectors are made in the USA to strict quality standards and are ready for fast delivery.



Male 4-Pin version shown above

## DIMENSIONAL DATA

All dimensions are in millimeters unless otherwise noted.

### MALE

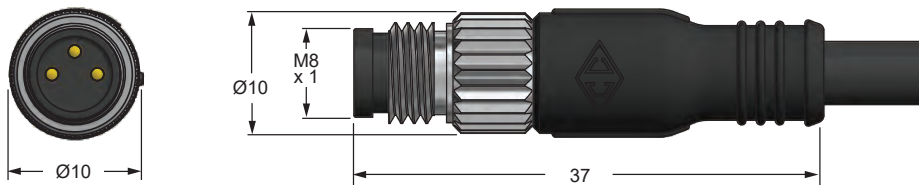

### FEMALE

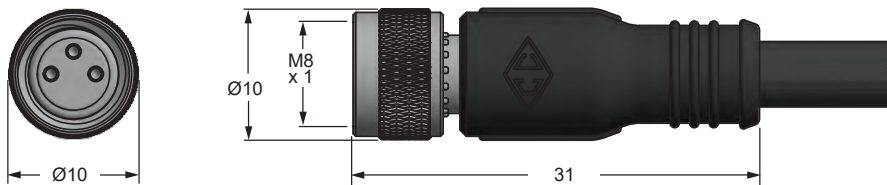

## PIN CONFIGURATION

### 3 Pin

Male      Female



Pin 1 = Brown  
Pin 3 = Blue  
Pin 4 = Black

### 4 Pin

Male      Female



Pin 1 = Brown  
Pin 2 = White  
Pin 3 = Blue  
Pin 4 = Black

## TECHNICAL DATA

<b>Current Max.</b>	4 Amps
<b>Voltage Max.</b>	120V AC/DC
<b>Materials</b>	Housing: PA, TPU Nut: Nickel Plated Brass Contacts: Gold Plated Brass
<b>Temperature Range</b>	-20° to +80°C
<b>Environmental Protection</b>	IP 68, IP 69 (Securely connected)
<b>Cable Diameter</b>	5.0mm
<b>Cable Type</b>	PVC, PUR
<b>Wire Gauge</b>	24 AWG
<b>Coding</b>	A - Standard

## ORDERING INFORMATION

Consult Factory for stock availability.

### M8 MALE STRAIGHT MOLDED LOCKING

Length	Wire Type	3 Pin	4 Pin
1 meter	PVC	RC08-AMM030-0110C10A	RC08-AMM040-0110C10A
	shielded	RC08-AMM030-0110S10A	RC08-AMM040-0110S10A
	PUR	RC08-AMM030-0110R10A	RC08-AMM040-0110R10A
	shielded	RC08-AMM030-0110P10A	RC08-AMM040-0110P10A
2 meter	PVC	RC08-AMM030-0120C10A	RC08-AMM040-0120C10A
	shielded	RC08-AMM030-0120S10A	RC08-AMM040-0120S10A
	PUR	RC08-AMM030-0120R10A	RC08-AMM040-0120R10A
	shielded	RC08-AMM030-0120P10A	RC08-AMM040-0120P10A
3 meter	PVC	RC08-AMM030-0130C10A	RC08-AMM040-0130C10A
	shielded	RC08-AMM030-0130S10A	RC08-AMM040-0130S10A
	PUR	RC08-AMM030-0130R10A	RC08-AMM040-0130R10A
	shielded	RC08-AMM030-0130P10A	RC08-AMM040-0130P10A
5 meter	PVC	RC08-AMM030-0150C10A	RC08-AMM040-0150C10A
	shielded	RC08-AMM030-0150S10A	RC08-AMM040-0150S10A
	PUR	RC08-AMM030-0150R10A	RC08-AMM040-0150R10A
	shielded	RC08-AMM030-0150P10A	RC08-AMM040-0150P10A
10 meter	PVC	RC08-AMM030-010AC10A	RC08-AMM040-010AC10A
	shielded	RC08-AMM030-010AS10A	RC08-AMM040-010AS10A
	PUR	RC08-AMM030-010AR10A	RC08-AMM040-010AR10A
	shielded	RC08-AMM030-010AP10A	RC08-AMM040-010AP10A

### M8 FEMALE STRAIGHT MOLDED LOCKING

Length	Wire Type	3 Pin	4 Pin
1 meter	PVC	RC08-AFM030-0110C10A	RC08-AFM040-0110C10A
	shielded	RC08-AFM030-0110S10A	RC08-AFM040-0110S10A
	PUR	RC08-AFM030-0110R10A	RC08-AFM040-0110R10A
	shielded	RC08-AFM030-0110P10A	RC08-AFM040-0110P10A
2 meter	PVC	RC08-AFM030-0120C10A	RC08-AFM040-0120C10A
	shielded	RC08-AFM030-0120S10A	RC08-AFM040-0120S10A
	PUR	RC08-AFM030-0120R10A	RC08-AFM040-0120R10A
	shielded	RC08-AFM030-0120P10A	RC08-AFM040-0120P10A
3 meter	PVC	RC08-AFM030-0130C10A	RC08-AFM040-0130C10A
	shielded	RC08-AFM030-0130S10A	RC08-AFM040-0130S10A
	PUR	RC08-AFM030-0130R10A	RC08-AFM040-0130R10A
	shielded	RC08-AFM030-0130P10A	RC08-AFM040-0130P10A
5 meter	PVC	RC08-AFM030-0150C10A	RC08-AFM040-0150C10A
	shielded	RC08-AFM030-0150S10A	RC08-AFM040-0150S10A
	PUR	RC08-AFM030-0150R10A	RC08-AFM040-0150R10A
	shielded	RC08-AFM030-0150P10A	RC08-AFM040-0150P10A
10 meter	PVC	RC08-AFM030-010AC10A	RC08-AFM040-010AC10A
	shielded	RC08-AFM030-010AS10A	RC08-AFM040-010AS10A
	PUR	RC08-AFM030-010AR10A	RC08-AFM040-010AR10A
	shielded	RC08-AFM030-010AP10A	RC08-AFM040-010AP10A

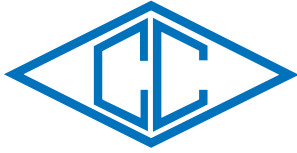

canfield  
connector

CANFast®  
round connectors

**M12 SERIES**  
12MM STRAIGHT  
MOLDED  
ROUND CONNECTORS

## GENERAL DESCRIPTION

Canfield Connector is known for its robust connections with an American twist, and the CANFAST® brand of M12 electrical connectors are no exception. This family of robust, all molded anti-vibration electrical connectors for sensors and actuators are specified by those needing a sure connection to valves, sensors, or automation of all types. Available in all industry styles including shielded and unshielded, and in various wire lengths. The CANFAST® round connectors are made in the USA to strict quality standards and are ready for fast delivery.



Male 3-Pin version shown above

## DIMENSIONAL DATA

All dimensions are in millimeters unless otherwise noted.

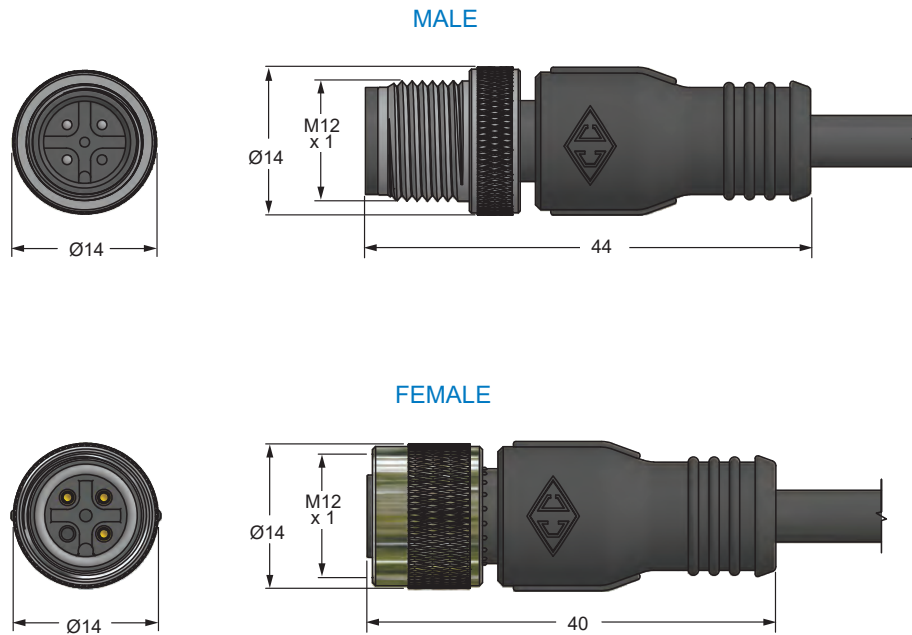

## PIN CONFIGURATION

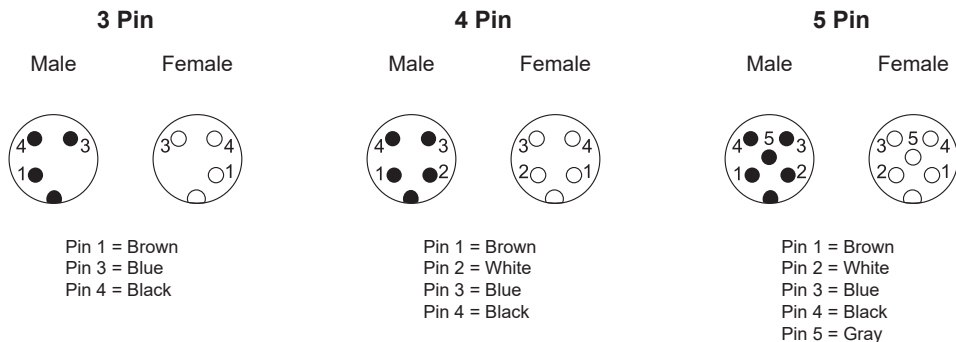



## TECHNICAL DATA

<b>Current Max.</b>	4 Amps
<b>Voltage Max.</b>	250V AC/DC
<b>Materials</b>	Housing: PA, TPU Nut: Nickel Plated Brass Contacts: Gold Plated Brass
<b>Temperature Range</b>	-20° to +80°C
<b>Environmental Protection</b>	IP 68, IP 69, IP 69K (Securely connected)
<b>Cable Diameter</b>	5.0mm
<b>Cable Type</b>	PVC, PUR
<b>Wire Gauge</b>	24 AWG
<b>Coding</b>	A - Standard

## ORDERING INFORMATION

Consult Factory for stock availability.

### M12 MALE STRAIGHT MOLDED LOCKING

Length	Wire Type	3 Pin	4 Pin	5 Pin
1 meter	PVC	RC12-AMM030-0110C10A	RC12-AMM040-0110C10A	RC12-AMM050-0110C10A
	shielded	RC12-AMM030-0110S10A	RC12-AMM040-0110S10A	RC12-AMM050-0110S10A
	PUR	RC12-AMM030-0110R10A	RC12-AMM040-0110R10A	RC12-AMM050-0110R10A
	shielded	RC12-AMM030-0110P10A	RC12-AMM040-0110P10A	RC12-AMM050-0110P10A
2 meter	PVC	RC12-AMM030-0120C10A	RC12-AMM040-0120C10A	RC12-AMM050-0120C10A
	shielded	RC12-AMM030-0120S10A	RC12-AMM040-0120S10A	RC12-AMM050-0120S10A
	PUR	RC12-AMM030-0120R10A	RC12-AMM040-0120R10A	RC12-AMM050-0120R10A
	shielded	RC12-AMM030-0120P10A	RC12-AMM040-0120P10A	RC12-AMM050-0120P10A
3 meter	PVC	RC12-AMM030-0130C10A	RC12-AMM040-0130C10A	RC12-AMM050-0130C10A
	shielded	RC12-AMM030-0130S10A	RC12-AMM040-0130S10A	RC12-AMM050-0130S10A
	PUR	RC12-AMM030-0130R10A	RC12-AMM040-0130R10A	RC12-AMM050-0130R10A
	shielded	RC12-AMM030-0130P10A	RC12-AMM040-0130P10A	RC12-AMM050-0130P10A
5 meter	PVC	RC12-AMM030-0150C10A	RC12-AMM040-0150C10A	RC12-AMM050-0150C10A
	shielded	RC12-AMM030-0150S10A	RC12-AMM040-0150S10A	RC12-AMM050-0150S10A
	PUR	RC12-AMM030-0150R10A	RC12-AMM040-0150R10A	RC12-AMM050-0150R10A
	shielded	RC12-AMM030-0150P10A	RC12-AMM040-0150P10A	RC12-AMM050-0150P10A
10 meter	PVC	RC12-AMM030-010AC10A	RC12-AMM040-010AC10A	RC12-AMM050-010AC10A
	shielded	RC12-AMM030-010AS10A	RC12-AMM040-010AS10A	RC12-AMM050-010AS10A
	PUR	RC12-AMM030-010AR10A	RC12-AMM040-010AR10A	RC12-AMM050-010AR10A
	shielded	RC12-AMM030-010AP10A	RC12-AMM040-010AP10A	RC12-AMM050-010AP10A

### M12 FEMALE STRAIGHT MOLDED LOCKING

Length	Wire Type	3 Pin	4 Pin	5 Pin
1 meter	PVC	RC12-AFM030-0110C10A	RC12-AFM040-0110C10A	RC12-AFM050-0110C10A
	shielded	RC12-AFM030-0110S10A	RC12-AFM040-0110S10A	RC12-AFM050-0110S10A
	PUR	RC12-AFM030-0110R10A	RC12-AFM040-0110R10A	RC12-AFM050-0110R10A
	shielded	RC12-AFM030-0110P10A	RC12-AFM040-0110P10A	RC12-AFM050-0110P10A
2 meter	PVC	RC12-AFM030-0120C10A	RC12-AFM040-0120C10A	RC12-AFM050-0120C10A
	shielded	RC12-AFM030-0120S10A	RC12-AFM040-0120S10A	RC12-AFM050-0120S10A
	PUR	RC12-AFM030-0120R10A	RC12-AFM040-0120R10A	RC12-AFM050-0120R10A
	shielded	RC12-AFM030-0120P10A	RC12-AFM040-0120P10A	RC12-AFM050-0120P10A
3 meter	PVC	RC12-AFM030-0130C10A	RC12-AFM040-0130C10A	RC12-AFM050-0130C10A
	shielded	RC12-AFM030-0130S10A	RC12-AFM040-0130S10A	RC12-AFM050-0130S10A
	PUR	RC12-AFM030-0130R10A	RC12-AFM040-0130R10A	RC12-AFM050-0130R10A
	shielded	RC12-AFM030-0130P10A	RC12-AFM040-0130P10A	RC12-AFM050-0130P10A
5 meter	PVC	RC12-AFM030-0150C10A	RC12-AFM040-0150C10A	RC12-AFM050-0150C10A
	shielded	RC12-AFM030-0150S10A	RC12-AFM040-0150S10A	RC12-AFM050-0150S10A
	PUR	RC12-AFM030-0150R10A	RC12-AFM040-0150R10A	RC12-AFM050-0150R10A
	shielded	RC12-AFM030-0150P10A	RC12-AFM040-0150P10A	RC12-AFM050-0150P10A
10 meter	PVC	RC12-AFM030-010AC10A	RC12-AFM040-010AC10A	RC12-AFM050-010AC10A
	shielded	RC12-AFM030-010AS10A	RC12-AFM040-010AS10A	RC12-AFM050-010AS10A
	PUR	RC12-AFM030-010AR10A	RC12-AFM040-010AR10A	RC12-AFM050-010AR10A
	shielded	RC12-AFM030-010AP10A	RC12-AFM040-010AP10A	RC12-AFM050-010AP10A



canfield  
connector

CANFAST®  
round connectors

**M12 SERIES**  
12MM 90°  
MOLDED  
ROUND CONNECTORS

### GENERAL DESCRIPTION

Canfield Connector is known for its robust connections with an American twist, and the CANFAST® brand of M12 90° electrical connectors for sensors and actuators are no exception. This family of robust, all molded anti-vibration electrical connectors for sensors and actuators are specified by those needing a sure connection to valves, sensors, or automation of all types. Available in all industry styles including shielded and unshielded, and in various wire lengths. The CANFAST® round connectors are made in the USA to strict quality standards and are ready for fast delivery.



Female 5-Pin version shown above

### DIMENSIONAL DATA

All dimensions are in millimeters unless otherwise noted.

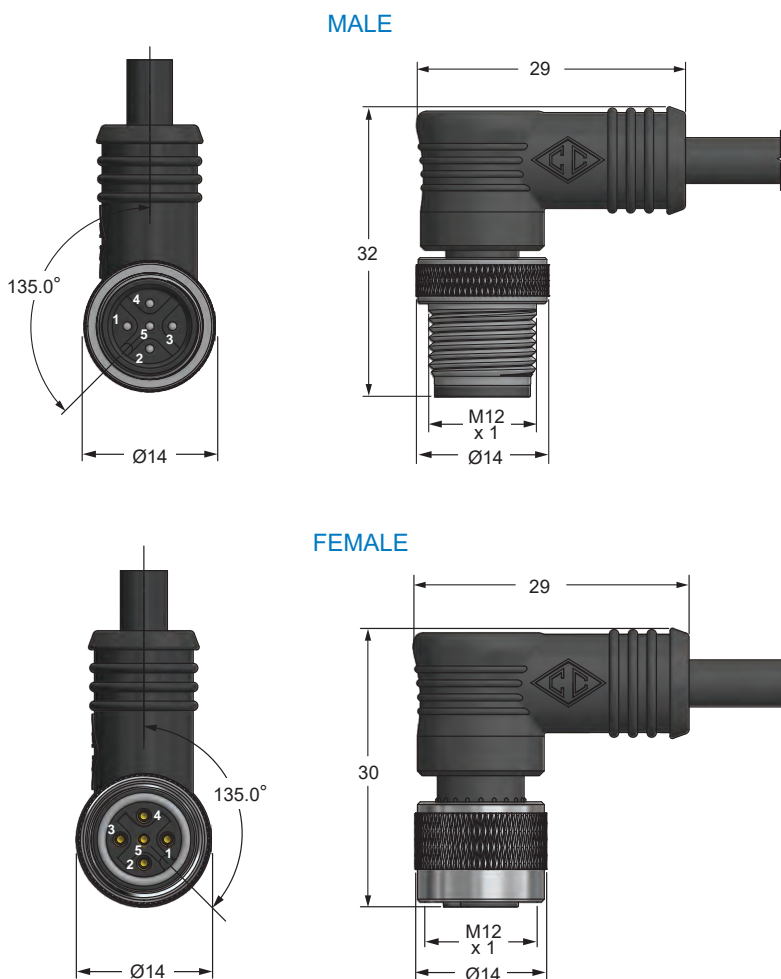

### PIN CONFIGURATION

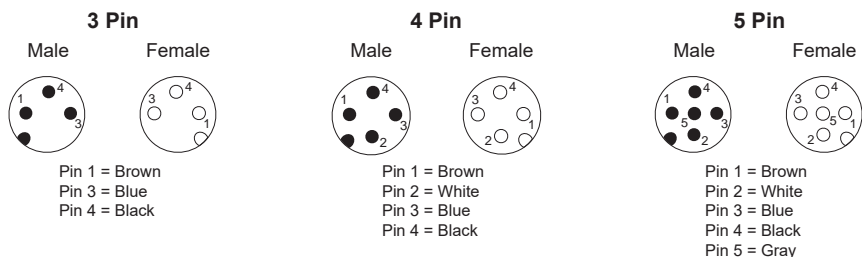

## TECHNICAL DATA

Current Max.	4 Amps
Voltage Max.	250V AC/DC
Materials	Housing: PA, TPU Nut: Nickel Plated Brass Contacts: Gold Plated Brass
Temperature Range	-20° to +80°C
Environmental Protection	IP 68, IP 69, IP 69K (Securely connected)
Cable Diameter	5.0mm
Cable Type	PVC, PUR
Wire Gauge	24 AWG
Coding	A - Standard

## ORDERING INFORMATION

Consult Factory for stock availability.

### M12 MALE 90° MOLDED LOCKING

Length	Wire Type	3 Pin	4 Pin	5 Pin
1 meter	PVC	RC12-AMM030-0210C10A	RC12-AMM040-0210C10A	RC12-AMM050-0210C10A
	shielded	RC12-AMM030-0210S10A	RC12-AMM040-0210S10A	RC12-AMM050-0210S10A
	PUR	RC12-AMM030-0210R10A	RC12-AMM040-0210R10A	RC12-AMM050-0210R10A
	shielded	RC12-AMM030-0210P10A	RC12-AMM040-0210P10A	RC12-AMM050-0210P10A
2 meter	PVC	RC12-AMM030-0220C10A	RC12-AMM040-0220C10A	RC12-AMM050-0220C10A
	shielded	RC12-AMM030-0220S10A	RC12-AMM040-0220S10A	RC12-AMM050-0220S10A
	PUR	RC12-AMM030-0220R10A	RC12-AMM040-0220R10A	RC12-AMM050-0220R10A
	shielded	RC12-AMM030-0220P10A	RC12-AMM040-0220P10A	RC12-AMM050-0220P10A
3 meter	PVC	RC12-AMM030-0230C10A	RC12-AMM040-0230C10A	RC12-AMM050-0230C10A
	shielded	RC12-AMM030-0230S10A	RC12-AMM040-0230S10A	RC12-AMM050-0230S10A
	PUR	RC12-AMM030-0230R10A	RC12-AMM040-0230R10A	RC12-AMM050-0230R10A
	shielded	RC12-AMM030-0230P10A	RC12-AMM040-0230P10A	RC12-AMM050-0230P10A
5 meter	PVC	RC12-AMM030-0250C10A	RC12-AMM040-0250C10A	RC12-AMM050-0250C10A
	shielded	RC12-AMM030-0250S10A	RC12-AMM040-0250S10A	RC12-AMM050-0250S10A
	PUR	RC12-AMM030-0250R10A	RC12-AMM040-0250R10A	RC12-AMM050-0250R10A
	shielded	RC12-AMM030-0250P10A	RC12-AMM040-0250P10A	RC12-AMM050-0250P10A
10 meter	PVC	RC12-AMM030-020AC10A	RC12-AMM040-020AC10A	RC12-AMM050-020AC10A
	shielded	RC12-AMM030-020AS10A	RC12-AMM040-020AS10A	RC12-AMM050-020AS10A
	PUR	RC12-AMM030-020AR10A	RC12-AMM040-020AR10A	RC12-AMM050-020AR10A
	shielded	RC12-AMM030-020AP10A	RC12-AMM040-020AP10A	RC12-AMM050-020AP10A

### M12 FEMALE 90° MOLDED LOCKING

Length	Wire Type	3 Pin	4 Pin	5 Pin
1 meter	PVC	RC12-AFM030-0210C10A	RC12-AFM040-0210C10A	RC12-AFM050-0210C10A
	shielded	RC12-AFM030-0210S10A	RC12-AFM040-0210S10A	RC12-AFM050-0210S10A
	PUR	RC12-AFM030-0210R10A	RC12-AFM040-0210R10A	RC12-AFM050-0210R10A
	shielded	RC12-AFM030-0210P10A	RC12-AFM040-0210P10A	RC12-AFM050-0210P10A
2 meter	PVC	RC12-AFM030-0220C10A	RC12-AFM040-0220C10A	RC12-AFM050-0220C10A
	shielded	RC12-AFM030-0220S10A	RC12-AFM040-0220S10A	RC12-AFM050-0220S10A
	PUR	RC12-AFM030-0220R10A	RC12-AFM040-0220R10A	RC12-AFM050-0220R10A
	shielded	RC12-AFM030-0220P10A	RC12-AFM040-0220P10A	RC12-AFM050-0220P10A
3 meter	PVC	RC12-AFM030-0230C10A	RC12-AFM040-0230C10A	RC12-AFM050-0230C10A
	shielded	RC12-AFM030-0230S10A	RC12-AFM040-0230S10A	RC12-AFM050-0230S10A
	PUR	RC12-AFM030-0230R10A	RC12-AFM040-0230R10A	RC12-AFM050-0230R10A
	shielded	RC12-AFM030-0230P10A	RC12-AFM040-0230P10A	RC12-AFM050-0230P10A
5 meter	PVC	RC12-AFM030-0250C10A	RC12-AFM040-0250C10A	RC12-AFM050-0250C10A
	shielded	RC12-AFM030-0250S10A	RC12-AFM040-0250S10A	RC12-AFM050-0250S10A
	PUR	RC12-AFM030-0250R10A	RC12-AFM040-0250R10A	RC12-AFM050-0250R10A
	shielded	RC12-AFM030-0250P10A	RC12-AFM040-0250P10A	RC12-AFM050-0250P10A
10 meter	PVC	RC12-AFM030-020AC10A	RC12-AFM040-020AC10A	RC12-AFM050-020AC10A
	shielded	RC12-AFM030-020AS10A	RC12-AFM040-020AS10A	RC12-AFM050-020AS10A
	PUR	RC12-AFM030-020AR10A	RC12-AFM040-020AR10A	RC12-AFM050-020AR10A
	shielded	RC12-AFM030-020AP10A	RC12-AFM040-020AP10A	RC12-AFM050-020AP10A



**canfield  
connector**

**CANFast**<sup>®</sup>  
round connectors

**M8 to M8 SERIES**  
8MM MALE STRAIGHT TO  
8MM MALE STRAIGHT  
RP MOLDED PATCH CORDS

## DIMENSIONAL DATA

All dimensions are in millimeters unless otherwise noted.

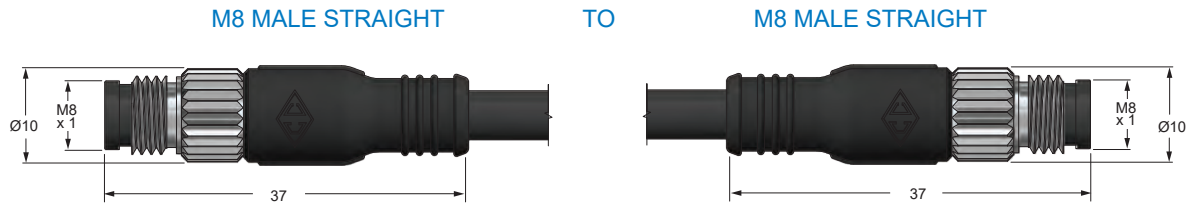

## M8 STRAIGHT PIN CONFIGURATION

**3 Pin**  
Male



Pin 1 = Brown  
Pin 3 = Blue  
Pin 4 = Black

**4 Pin**  
Male



Pin 1 = Brown  
Pin 2 = White  
Pin 3 = Blue  
Pin 4 = Black

## ORDERING INFORMATION

Consult Factory for stock availability.

### M8 MALE STRAIGHT TO M8 MALE STRAIGHT

Length	Wire Type	3 Pin	4 Pin
1 meter	PVC	RP08AMM030110C10-08AMM031A	RP08AMM040110C10-08AMM041A
	shielded	RP08AMM030110S10-08AMM031A	RP08AMM040110S10-08AMM041A
	PUR	RP08AMM030110R10-08AMM031A	RP08AMM040110R10-08AMM041A
	shielded	RP08AMM030110P10-08AMM031A	RP08AMM040110P10-08AMM041A
2 meter	PVC	RP08AMM030120C10-08AMM031A	RP08AMM040120C10-08AMM041A
	shielded	RP08AMM030120S10-08AMM031A	RP08AMM040120S10-08AMM041A
	PUR	RP08AMM030120R10-08AMM031A	RP08AMM040120R10-08AMM041A
	shielded	RP08AMM030120P10-08AMM031A	RP08AMM040120P10-08AMM041A
3 meter	PVC	RP08AMM030130C10-08AMM031A	RP08AMM040130C10-08AMM041A
	shielded	RP08AMM030130S10-08AMM031A	RP08AMM040130S10-08AMM041A
	PUR	RP08AMM030130R10-08AMM031A	RP08AMM040130R10-08AMM041A
	shielded	RP08AMM030130P10-08AMM031A	RP08AMM040130P10-08AMM041A
5 meter	PVC	RP08AMM030150C10-08AMM031A	RP08AMM040150C10-08AMM041A
	shielded	RP08AMM030150S10-08AMM031A	RP08AMM040150S10-08AMM041A
	PUR	RP08AMM030150R10-08AMM031A	RP08AMM040150R10-08AMM041A
	shielded	RP08AMM030150P10-08AMM031A	RP08AMM040150P10-08AMM041A
10 meter	PVC	RP08AMM03010AC10-08AMM031A	RP08AMM04010AC10-08AMM041A
	shielded	RP08AMM03010AS10-08AMM031A	RP08AMM04010AS10-08AMM041A
	PUR	RP08AMM03010AR10-08AMM031A	RP08AMM04010AR10-08AMM041A
	shielded	RP08AMM03010AP10-08AMM031A	RP08AMM04010AP10-08AMM041A

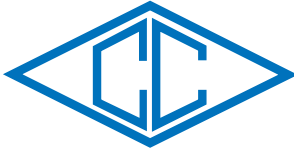

**canfield  
connector**

**CANFast**<sup>®</sup>  
round connectors

**M8 to M8 SERIES**  
8MM MALE STRAIGHT TO  
8MM FEMALE STRAIGHT  
RP MOLDED PATCH CORDS

## DIMENSIONAL DATA

All dimensions are in millimeters unless otherwise noted.

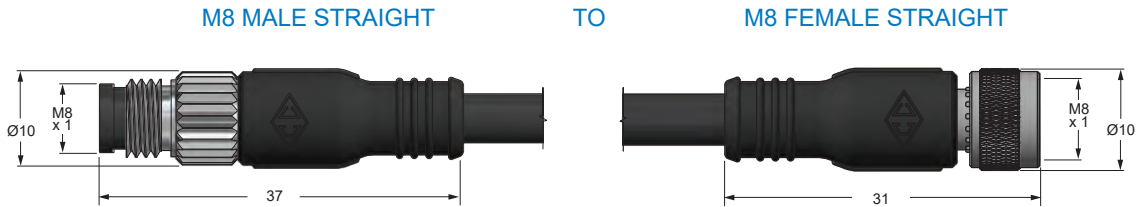

## M8 STRAIGHT PIN CONFIGURATION

### 3 Pin

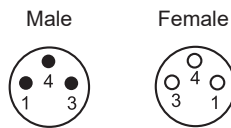

Pin 1 = Brown  
Pin 3 = Blue  
Pin 4 = Black

### 4 Pin

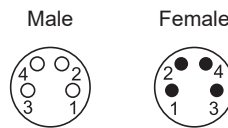

Pin 1 = Brown  
Pin 2 = White  
Pin 3 = Blue  
Pin 4 = Black

## ORDERING INFORMATION

Consult Factory for stock availability.

### M8 MALE STRAIGHT TO M8 FEMALE STRAIGHT

Length	Wire Type	3 Pin	4 Pin
1 meter	PVC	RP08AMM030110C10-08AFM031A	RP08AMM040110C10-08AFM041A
	shielded	RP08AMM030110S10-08AFM031A	RP08AMM040110S10-08AFM041A
	PUR	RP08AMM030110R10-08AFM031A	RP08AMM040110R10-08AFM041A
	shielded	RP08AMM030110CP10-08AFM031A	RP08AMM040110P10-08AFM041A
2 meter	PVC	RP08AMM030120C10-08AFM031A	RP08AMM040120C10-08AFM041A
	shielded	RP08AMM030120S10-08AFM031A	RP08AMM040120S10-08AFM041A
	PUR	RP08AMM030120R10-08AFM031A	RP08AMM040120R10-08AFM041A
	shielded	RP08AMM030120P10-08AFM031A	RP08AMM040120P10-08AFM041A
3 meter	PVC	RP08AMM030130C10-08AFM031A	RP08AMM040130C10-08AFM041A
	shielded	RP08AMM030130S10-08AFM031A	RP08AMM040130S10-08AFM041A
	PUR	RP08AMM030130R10-08AFM031A	RP08AMM040130R10-08AFM041A
	shielded	RP08AMM030130P10-08AFM031A	RP08AMM040130P10-08AFM041A
5 meter	PVC	RP08AMM030150C10-08AFM031A	RP08AMM040150C10-08AFM041A
	shielded	RP08AMM030150S10-08AFM031A	RP08AMM040150S10-08AFM041A
	PUR	RP08AMM030150R10-08AFM031A	RP08AMM040150R10-08AFM041A
	shielded	RP08AMM030150P10-08AFM031A	RP08AMM040150P10-08AFM041A
10 meter	PVC	RP08AMM03010AC10-08AFM031A	RP08AMM04010AC10-08AFM041A
	shielded	RP08AMM03010AS10-08AFM031A	RP08AMM04010AS10-08AFM041A
	PUR	RP08AMM03010AR10-08AFM031A	RP08AMM04010AR10-08AFM041A
	shielded	RP08AMM03010AP10-08AFM031A	RP08AMM04010AP10-08AFM041A

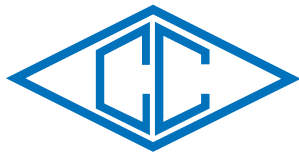

**canfield  
connector**

**CANFast**<sup>®</sup>  
round connectors

**M8 to M8 SERIES**  
8MM FEMALE STRAIGHT TO  
8MM FEMALE STRAIGHT  
RP MOLDED PATCH CORDS

## DIMENSIONAL DATA

All dimensions are in millimeters unless otherwise noted.

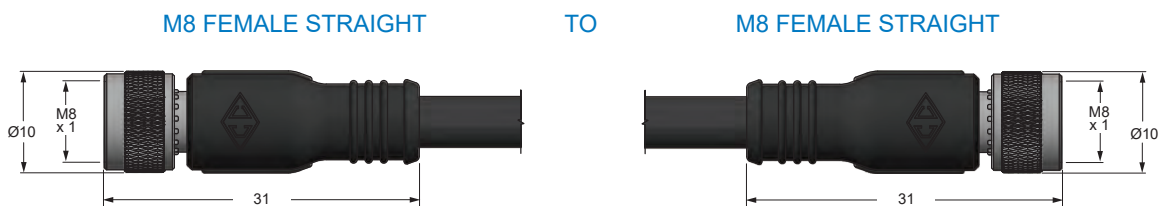

## M8 STRAIGHT PIN CONFIGURATION

**3 Pin  
Female**



Pin 1 = Brown  
Pin 3 = Blue  
Pin 4 = Black

**4 Pin  
Female**



Pin 1 = Brown  
Pin 2 = White  
Pin 3 = Blue  
Pin 4 = Black

## ORDERING INFORMATION

Consult Factory for stock availability.

### M8 FEMALE STRAIGHT TO M8 FEMALE STRAIGHT

Length	Wire Type	3 Pin	4 Pin
1 meter	PVC	RP08AFM030110C10-08AFM031A	RP08AFM040110C10-08AFM041A
	shielded	RP08AFM030110S10-08AFM031A	RP08AFM040110S10-08AFM041A
	PUR	RP08AFM030110R10-08AFM031A	RP08AFM040110R10-08AFM041A
	shielded	RP08AFM030110P10-08AFM031A	RP08AFM040110P10-08AFM041A
2 meter	PVC	RP08AFM030120C10-08AFM031A	RP08AFM040120C10-08AFM041A
	shielded	RP08AFM030120S10-08AFM031A	RP08AFM040120S10-08AFM041A
	PUR	RP08AFM030120R10-08AFM031A	RP08AFM040120R10-08AFM041A
	shielded	RP08AFM030120P10-08AFM031A	RP08AFM040120P10-08AFM041A
3 meter	PVC	RP08AFM030130C10-08AFM031A	RP08AFM040130C10-08AFM041A
	shielded	RP08AFM030130S10-08AFM031A	RP08AFM040130S10-08AFM041A
	PUR	RP08AFM030130R10-08AFM031A	RP08AFM040130R10-08AFM041A
	shielded	RP08AFM030130P10-08AFM031A	RP08AFM040130P10-08AFM041A
5 meter	PVC	RP08AFM030150C10-08AFM031A	RP08AFM040150C10-08AFM041A
	shielded	RP08AFM030150S10-08AFM031A	RP08AFM040150S10-08AFM041A
	PUR	RP08AFM030150R10-08AFM031A	RP08AFM040150R10-08AFM041A
	shielded	RP08AFM030150P10-08AFM031A	RP08AFM040150P10-08AFM041A
10 meter	PVC	RP08AFM03010AC10-08AFM031A	RP08AFM04010AC10-08AFM041A
	shielded	RP08AFM03010AS10-08AFM031A	RP08AFM04010AS10-08AFM041A
	PUR	RP08AFM03010AR10-08AFM031A	RP08AFM04010AR10-08AFM041A
	shielded	RP08AFM03010AP10-08AFM031A	RP08AFM04010AP10-08AFM041A

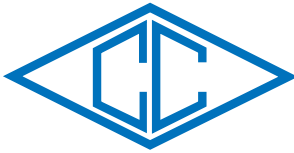

**canfield  
connector**

**CANFast**<sup>®</sup>  
round connectors

**M12 to M12 SERIES**  
12MM MALE STRAIGHT TO  
12MM MALE STRAIGHT  
RP MOLDED PATCH CORDS

## DIMENSIONAL DATA

All dimensions are in millimeters unless otherwise noted.

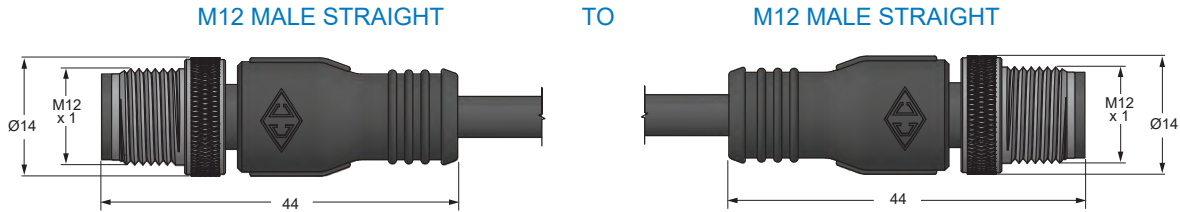

## M12 STRAIGHT PIN CONFIGURATION

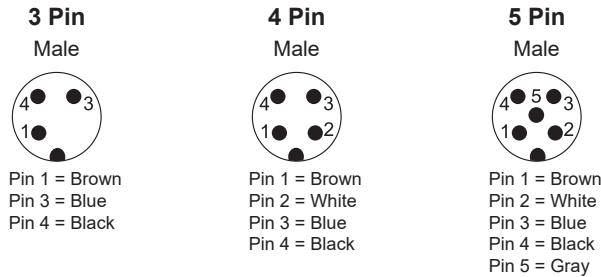

## ORDERING INFORMATION

Consult Factory for stock availability.

### M12 MALE STRAIGHT TO M12 MALE STRAIGHT

Length	Wire Type	3 Pin	4 Pin	5 Pin
1 meter	PVC	RP12AMM030110C10-12AMM031A	RP12AMM040110C10-12AMM041A	RP12AMM050110C10-12AMM051A
	shielded	RP12AMM030110S10-12AMM031A	RP12AMM040110S10-12AMM041A	RP12AMM050110S10-12AMM051A
	PUR	RP12AMM030110R10-12AMM031A	RP12AMM040110R10-12AMM041A	RP12AMM050110R10-12AMM051A
	shielded	RP12AMM030110P10-12AMM031A	RP12AMM040110P10-12AMM041A	RP12AMM050110P10-12AMM051A
2 meter	PVC	RP12AMM030120C10-12AMM031A	RP12AMM040120C10-12AMM041A	RP12AMM050120C10-12AMM051A
	shielded	RP12AMM030120S10-12AMM031A	RP12AMM040120S10-12AMM041A	RP12AMM050120S10-12AMM051A
	PUR	RP12AMM030120R10-12AMM031A	RP12AMM040120R10-12AMM041A	RP12AMM050120R10-12AMM051A
	shielded	RP12AMM030120P10-12AMM031A	RP12AMM040120P10-12AMM041A	RP12AMM050120P10-12AMM051A
3 meter	PVC	RP12AMM030130C10-12AMM031A	RP12AMM040130C10-12AMM041A	RP12AMM050130C10-12AMM051A
	shielded	RP12AMM030130S10-12AMM031A	RP12AMM040130S10-12AMM041A	RP12AMM050130S10-12AMM051A
	PUR	RP12AMM030130R10-12AMM031A	RP12AMM040130R10-12AMM041A	RP12AMM050130R10-12AMM051A
	shielded	RP12AMM030130P10-12AMM031A	RP12AMM040130P10-12AMM041A	RP12AMM050130P10-12AMM051A
5 meter	PVC	RP12AMM030150C10-12AMM031A	RP12AMM040150C10-12AMM041A	RP12AMM050150C10-12AMM051A
	shielded	RP12AMM030150S10-12AMM031A	RP12AMM040150S10-12AMM041A	RP12AMM050150S10-12AMM051A
	PUR	RP12AMM030150R10-12AMM031A	RP12AMM040150R10-12AMM041A	RP12AMM050150R10-12AMM051A
	shielded	RP12AMM030150P10-12AMM031A	RP12AMM040150P10-12AMM041A	RP12AMM050150P10-12AMM051A
10 meter	PVC	RP12AMM03010AC10-12AMM031A	RP12AMM04010AC10-12AMM041A	RP12AMM05010AC10-12AMM051A
	shielded	RP12AMM03010AS10-12AMM031A	RP12AMM04010AS10-12AMM041A	RP12AMM05010AS10-12AMM051A
	PUR	RP12AMM03010AR10-12AMM031A	RP12AMM04010AR10-12AMM041A	RP12AMM05010AR10-12AMM051A
	shielded	RP12AMM03010AP10-12AMM031A	RP12AMM04010AP10-12AMM041A	RP12AMM05010AP10-12AMM051A

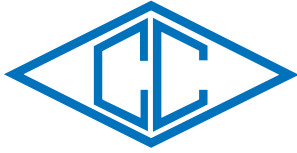

**canfield  
connector**

**CANFast**<sup>®</sup>  
round connectors

**M12 to M12 SERIES**  
12MM MALE STRAIGHT TO  
12MM FEMALE STRAIGHT  
RP MOLDED PATCH CORDS

## DIMENSIONAL DATA

All dimensions are in millimeters unless otherwise noted.

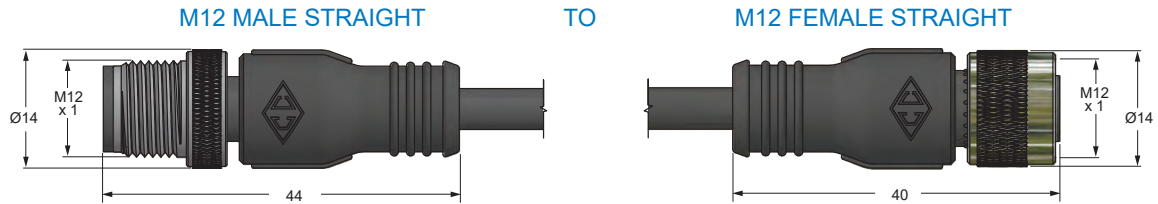

## M12 STRAIGHT PIN CONFIGURATION

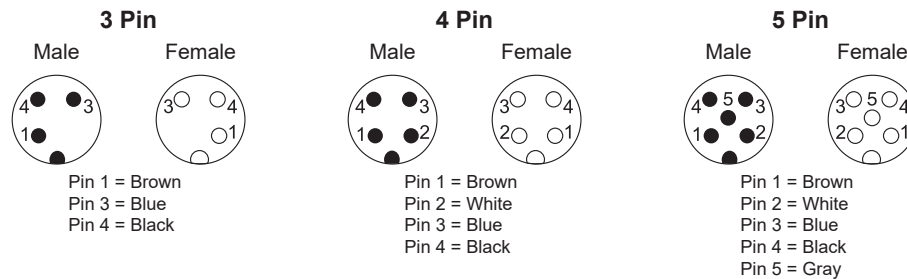

## ORDERING INFORMATION

Consult Factory for stock availability.

### M12 MALE STRAIGHT TO M12 FEMALE STRAIGHT

Length	Wire Type	3 Pin	4 Pin	5 Pin
1 meter	PVC	RP12AMM030110C10-12AFM031A	RP12AMM040110C10-12AFM041A	RP12AMM050110C10-12AFM051A
	shielded	RP12AMM030110S10-12AFM031A	RP12AMM040110S10-12AFM041A	RP12AMM050110S10-12AFM051A
	PUR	RP12AMM030110R10-12AFM031A	RP12AMM040110R10-12AFM041A	RP12AMM050110R10-12AFM051A
	shielded	RP12AMM030110P10-12AFM031A	RP12AMM040110P10-12AFM041A	RP12AMM050110P10-12AFM051A
2 meter	PVC	RP12AMM030120C10-12AFM031A	RP12AMM040120C10-12AFM041A	RP12AMM050120C10-12AFM051A
	shielded	RP12AMM030120S10-12AFM031A	RP12AMM040120S10-12AFM041A	RP12AMM050120S10-12AFM051A
	PUR	RP12AMM030120R10-12AFM031A	RP12AMM040120R10-12AFM041A	RP12AMM050120R10-12AFM051A
	shielded	RP12AMM030120P10-12AFM031A	RP12AMM040120P10-12AFM041A	RP12AMM050120P10-12AFM051A
3 meter	PVC	RP12AMM030130C10-12AFM031A	RP12AMM040130C10-12AFM041A	RP12AMM050130C10-12AFM051A
	shielded	RP12AMM030130S10-12AFM031A	RP12AMM040130S10-12AFM041A	RP12AMM050130S10-12AFM051A
	PUR	RP12AMM030130R10-12AFM031A	RP12AMM040130R10-12AFM041A	RP12AMM050130R10-12AFM051A
	shielded	RP12AMM030130P10-12AFM031A	RP12AMM040130P10-12AFM041A	RP12AMM050130P10-12AFM051A
5 meter	PVC	RP12AMM030150C10-12AFM031A	RP12AMM040150C10-12AFM041A	RP12AMM050150C10-12AFM051A
	shielded	RP12AMM030150S10-12AFM031A	RP12AMM040150S10-12AFM041A	RP12AMM050150S10-12AFM051A
	PUR	RP12AMM030150R10-12AFM031A	RP12AMM040150R10-12AFM041A	RP12AMM050150R10-12AFM051A
	shielded	RP12AMM030150P10-12AFM031A	RP12AMM040150P10-12AFM041A	RP12AMM050150P10-12AFM051A
10 meter	PVC	RP12AMM03010AC10-12AFM031A	RP12AMM04010AC10-12AFM041A	RP12AMM05010AC10-12AFM051A
	shielded	RP12AMM03010AS10-12AFM031A	RP12AMM04010AS10-12AFM041A	RP12AMM05010AS10-12AFM051A
	PUR	RP12AMM03010AR10-12AFM031A	RP12AMM04010AR10-12AFM041A	RP12AMM05010AR10-12AFM051A
	shielded	RP12AMM03010AP10-12AFM031A	RP12AMM04010AP10-12AFM041A	RP12AMM05010AP10-12AFM051A





**canfield  
connector**

**CANFast**<sup>®</sup>  
round connectors

**M12 to M12 SERIES**  
12MM FEMALE STRAIGHT TO  
12MM FEMALE STRAIGHT  
RP MOLDED PATCH CORDS

## DIMENSIONAL DATA

All dimensions are in millimeters unless otherwise noted.

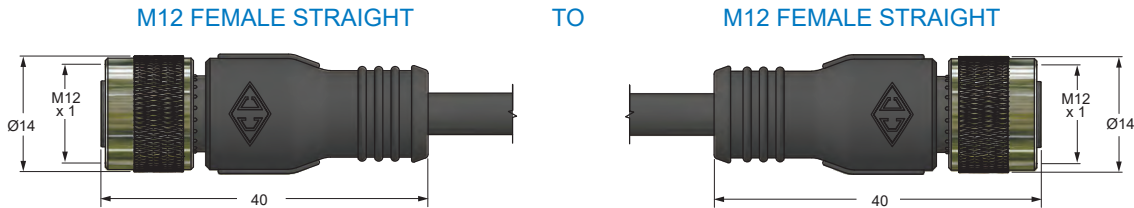

## M12 STRAIGHT PIN CONFIGURATION

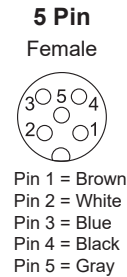
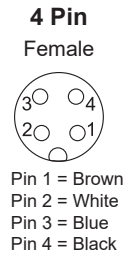
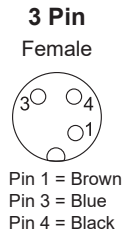

## ORDERING INFORMATION

Consult Factory for stock availability.

### M12 FEMALE STRAIGHT TO M12 FEMALE STRAIGHT

Length	Wire Type	3 Pin	4 Pin	5 Pin
1 meter	PVC	RP12AFM030110C10-12AFM031A	RP12AFM040110C10-12AFM041A	RP12AFM050110C10-12AFM051A
	shielded	RP12AFM030110S10-12AFM031A	RP12AFM040110S10-12AFM041A	RP12AFM050110S10-12AFM051A
	PUR	RP12AFM030110R10-12AFM031A	RP12AFM040110R10-12AFM041A	RP12AFM050110R10-12AFM051A
	shielded	RP12AFM030110P10-12AFM031A	RP12AFM040110P10-12AFM041A	RP12AFM050110P10-12AFM051A
2 meter	PVC	RP12AFM030120C10-12AFM031A	RP12AFM040120C10-12AFM041A	RP12AFM050120C10-12AFM051A
	shielded	RP12AFM030120S10-12AFM031A	RP12AFM040120S10-12AFM041A	RP12AFM050120S10-12AFM051A
	PUR	RP12AFM030120R10-12AFM031A	RP12AFM040120R10-12AFM041A	RP12AFM050120R10-12AFM051A
	shielded	RP12AFM030120P10-12AFM031A	RP12AFM040120P10-12AFM041A	RP12AFM050120P10-12AFM051A
3 meter	PVC	RP12AFM030130C10-12AFM031A	RP12AFM040130C10-12AFM041A	RP12AFM050130C10-12AFM051A
	shielded	RP12AFM030130S10-12AFM031A	RP12AFM040130S10-12AFM041A	RP12AFM050130S10-12AFM051A
	PUR	RP12AFM030130R10-12AFM031A	RP12AFM040130R10-12AFM041A	RP12AFM050130R10-12AFM051A
	shielded	RP12AFM030130P10-12AFM031A	RP12AFM040130P10-12AFM041A	RP12AFM050130P10-12AFM051A
5 meter	PVC	RP12AFM030150C10-12AFM031A	RP12AFM040150C10-12AFM041A	RP12AFM050150C10-12AFM051A
	shielded	RP12AFM030150S10-12AFM031A	RP12AFM040150S10-12AFM041A	RP12AFM050150S10-12AFM051A
	PUR	RP12AFM030150R10-12AFM031A	RP12AFM040150R10-12AFM041A	RP12AFM050150R10-12AFM051A
	shielded	RP12AFM030150P10-12AFM031A	RP12AFM040150P10-12AFM041A	RP12AFM050150P10-12AFM051A
10 meter	PVC	RP12AFM03010AC10-12AFM031A	RP12AFM04010AC10-12AFM041A	RP12AFM05010AC10-12AFM051A
	shielded	RP12AFM03010AS10-12AFM031A	RP12AFM04010AS10-12AFM041A	RP12AFM05010AS10-12AFM051A
	PUR	RP12AFM03010AR10-12AFM031A	RP12AFM04010AR10-12AFM041A	RP12AFM05010AR10-12AFM051A
	shielded	RP12AFM03010AP10-12AFM031A	RP12AFM04010AP10-12AFM041A	RP12AFM05010AP10-12AFM051A



**canfield  
connector**

**CANFast**<sup>®</sup>  
round connectors

**M12 to M12 SERIES**  
12MM MALE 90° TO  
12MM MALE 90°  
RP MOLDED PATCH CORDS

## DIMENSIONAL DATA

All dimensions are in millimeters unless otherwise noted.

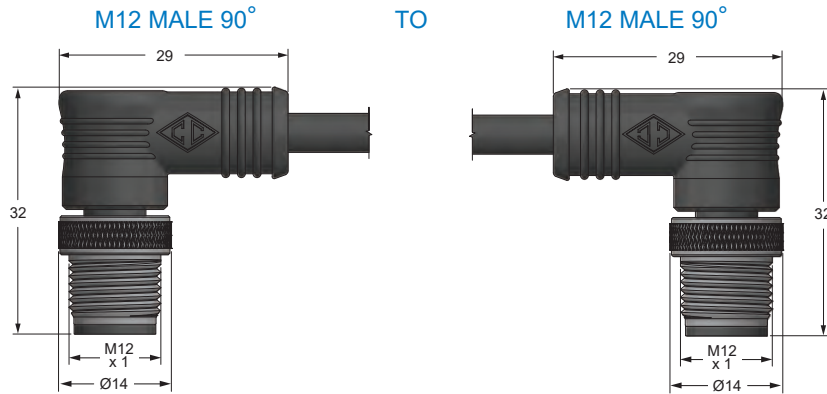

## M12 90° PIN CONFIGURATION

**3 Pin**  
Male

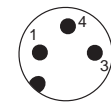

Pin 1 = Brown  
Pin 3 = Blue  
Pin 4 = Black

**4 Pin**  
Male

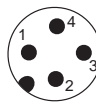

Pin 1 = Brown  
Pin 2 = White  
Pin 3 = Blue  
Pin 4 = Black

**5 Pin**  
Male

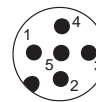

Pin 1 = Brown  
Pin 2 = White  
Pin 3 = Blue  
Pin 4 = Black  
Pin 5 = Gray

## ORDERING INFORMATION

Consult Factory for stock availability.

### M12 MALE 90° TO M12 MALE 90°

Length	Wire Type	3 Pin	4 Pin	5 Pin
1 meter	PVC	RP12AMM030210C10-12AMM032A	RP12AMM040210C10-12AMM042A	RP12AMM050210C10-12AMM052A
	shielded	RP12AMM030210S10-12AMM032A	RP12AMM040210S10-12AMM042A	RP12AMM050210S10-12AMM052A
	PUR	RP12AMM030210R10-12AMM032A	RP12AMM040210R10-12AMM042A	RP12AMM050210R10-12AMM052A
	shielded	RP12AMM030210P10-12AMM032A	RP12AMM040210P10-12AMM042A	RP12AMM050210P10-12AMM052A
2 meter	PVC	RP12AMM030220C10-12AMM032A	RP12AMM040220C10-12AMM042A	RP12AMM050220C10-12AMM052A
	shielded	RP12AMM030220S10-12AMM032A	RP12AMM040220S10-12AMM042A	RP12AMM050220S10-12AMM052A
	PUR	RP12AMM030220R10-12AMM032A	RP12AMM040220R10-12AMM042A	RP12AMM050220R10-12AMM052A
	shielded	RP12AMM030220P10-12AMM032A	RP12AMM040220P10-12AMM042A	RP12AMM050220P10-12AMM052A
3 meter	PVC	RP12AMM030230C10-12AMM032A	RP12AMM040230C10-12AMM042A	RP12AMM050230C10-12AMM052A
	shielded	RP12AMM030230S10-12AMM032A	RP12AMM040230S10-12AMM042A	RP12AMM050230S10-12AMM052A
	PUR	RP12AMM030230R10-12AMM032A	RP12AMM040230R10-12AMM042A	RP12AMM050230R10-12AMM052A
	shielded	RP12AMM030230P10-12AMM032A	RP12AMM040230P10-12AMM042A	RP12AMM050230P10-12AMM052A
5 meter	PVC	RP12AMM030250C10-12AMM032A	RP12AMM040250C10-12AMM042A	RP12AMM050250C10-12AMM052A
	shielded	RP12AMM030250S10-12AMM032A	RP12AMM040250S10-12AMM042A	RP12AMM050250S10-12AMM052A
	PUR	RP12AMM030250R10-12AMM032A	RP12AMM040250R10-12AMM042A	RP12AMM050250R10-12AMM052A
	shielded	RP12AMM030250P10-12AMM032A	RP12AMM040250P10-12AMM042A	RP12AMM050250P10-12AMM052A
10 meter	PVC	RP12AMM03020AC10-12AMM032A	RP12AMM04020AC10-12AMM042A	RP12AMM05020AC10-12AMM052A
	shielded	RP12AMM03020AS10-12AMM032A	RP12AMM04020AS10-12AMM042A	RP12AMM05020AS10-12AMM052A
	PUR	RP12AMM03020AR10-12AMM032A	RP12AMM04020AR10-12AMM042A	RP12AMM05020AR10-12AMM052A
	shielded	RP12AMM03020AP10-12AMM032A	RP12AMM04020AP10-12AMM042A	RP12AMM05020AP10-12AMM052A



**canfield  
connector**

**CANFast**  
round connectors

**M12 to M12 SERIES**  
12MM MALE 90° TO  
12MM FEMALE 90°  
RP MOLDED PATCH CORDS

## DIMENSIONAL DATA

All dimensions are in millimeters unless otherwise noted.

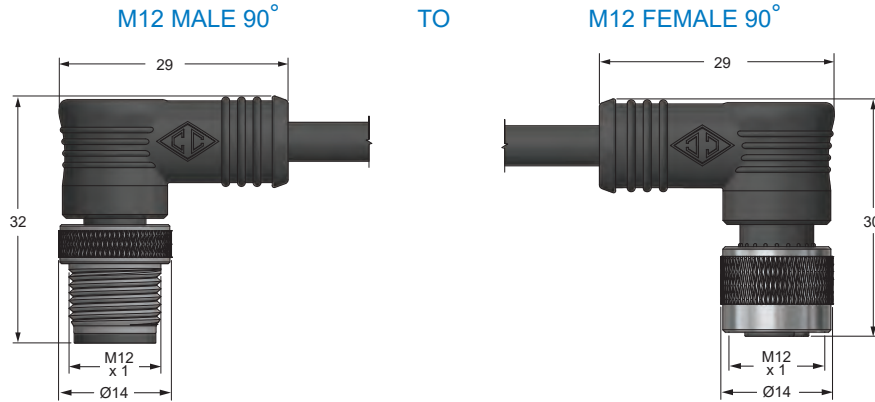

### M12 90° PIN CONFIGURATION

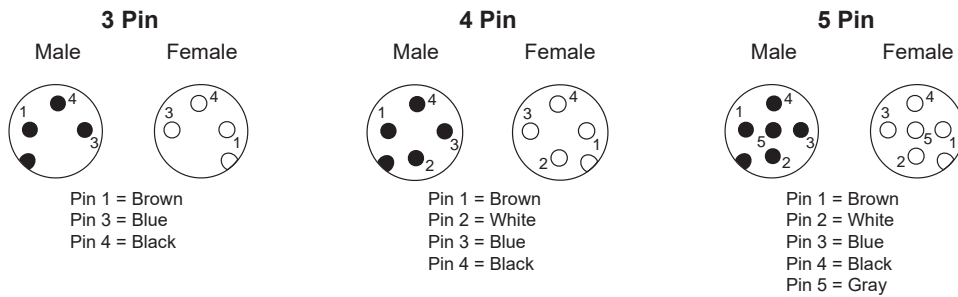

## ORDERING INFORMATION

Consult Factory for stock availability.

### M12 MALE 90° TO M12 FEMALE 90°

Length	Wire Type	3 Pin	4 Pin	5 Pin
1 meter	PVC	RP12AMM030210C10-12AFM032A	RP12AMM040210C10-12AFM042A	RP12AMM050210C10-12AFM052A
	shielded	RP12AMM030210S10-12AFM032A	RP12AMM040210S10-12AFM042A	RP12AMM050210S10-12AFM052A
	PUR	RP12AMM030210R10-12AFM032A	RP12AMM040210R10-12AFM042A	RP12AMM050210R10-12AFM052A
	shielded	RP12AMM030210P10-12AFM032A	RP12AMM040210P10-12AFM042A	RP12AMM050210P10-12AFM052A
2 meter	PVC	RP12AMM030220C10-12AFM032A	RP12AMM040220C10-12AFM042A	RP12AMM050220C10-12AFM052A
	shielded	RP12AMM030220S10-12AFM032A	RP12AMM040220S10-12AFM042A	RP12AMM050220S10-12AFM052A
	PUR	RP12AMM030220R10-12AFM032A	RP12AMM040220R10-12AFM042A	RP12AMM050220R10-12AFM052A
	shielded	RP12AMM030220P10-12AFM032A	RP12AMM040220P10-12AFM042A	RP12AMM050220P10-12AFM052A
3 meter	PVC	RP12AMM030230C10-12AFM032A	RP12AMM040230C10-12AFM042A	RP12AMM050230C10-12AFM052A
	shielded	RP12AMM030230S10-12AFM032A	RP12AMM040230S10-12AFM042A	RP12AMM050230S10-12AFM052A
	PUR	RP12AMM030230R10-12AFM032A	RP12AMM040230R10-12AFM042A	RP12AMM050230R10-12AFM052A
	shielded	RP12AMM030230P10-12AFM032A	RP12AMM040230P10-12AFM042A	RP12AMM050230P10-12AFM052A
5 meter	PVC	RP12AMM030250C10-12AFM032A	RP12AMM040250C10-12AFM042A	RP12AMM050250C10-12AFM052A
	shielded	RP12AMM030250S10-12AFM032A	RP12AMM040250S10-12AFM042A	RP12AMM050250S10-12AFM052A
	PUR	RP12AMM030250R10-12AFM032A	RP12AMM040250R10-12AFM042A	RP12AMM050250R10-12AFM052A
	shielded	RP12AMM030250P10-12AFM032A	RP12AMM040250P10-12AFM042A	RP12AMM050250P10-12AFM052A
10 meter	PVC	RP12AMM03020AC10-12AFM032A	RP12AMM04020AC10-12AFM042A	RP12AMM05020AC10-12AFM052A
	shielded	RP12AMM03020AS10-12AFM032A	RP12AMM04020AS10-12AFM042A	RP12AMM05020AS10-12AFM052A
	PUR	RP12AMM03020AR10-12AFM032A	RP12AMM04020AR10-12AFM042A	RP12AMM05020AR10-12AFM052A
	shielded	RP12AMM03020AP10-12AFM032A	RP12AMM04020AP10-12AFM042A	RP12AMM05020AP10-12AFM052A



**canfield  
connector**

**CANFast**<sup>®</sup>  
round connectors

**M12 to M12 SERIES**  
12MM FEMALE 90° TO  
12MM FEMALE 90°  
RP MOLDED PATCH CORDS

## DIMENSIONAL DATA

All dimensions are in millimeters unless otherwise noted.

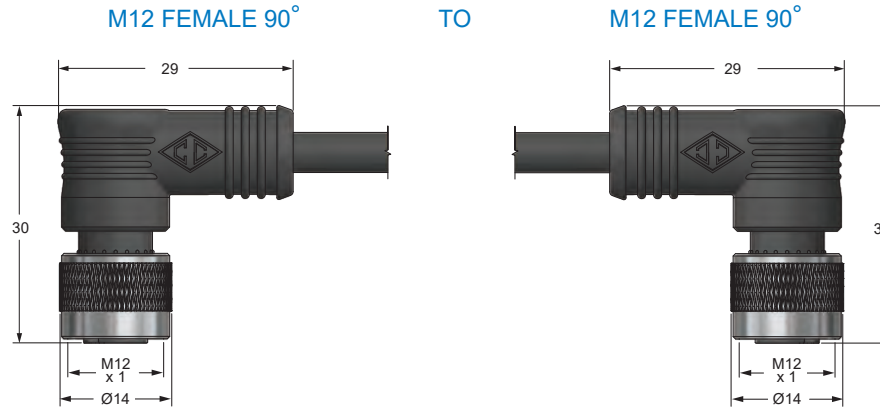

### M12 90° PIN CONFIGURATION

**3 Pin  
Female**

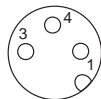

Pin 1 = Brown  
Pin 3 = Blue  
Pin 4 = Black

**4 Pin  
Female**

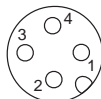

Pin 1 = Brown  
Pin 2 = White  
Pin 3 = Blue  
Pin 4 = Black

**5 Pin  
Female**

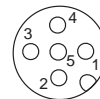

Pin 1 = Brown  
Pin 2 = White  
Pin 3 = Blue  
Pin 4 = Black  
Pin 5 = Gray

## ORDERING INFORMATION

Consult Factory for stock availability.

### M12 FEMALE 90° TO M12 FEMALE 90°

Length	Wire Type	3 Pin	4 Pin	5 Pin
1 meter	PVC	RP12AFM030210C10-12AFM032A	RP12AFM040210C10-12AFM042A	RP12AFM050210C10-12AFM052A
	shielded	RP12AFM030210S10-12AFM032A	RP12AFM040210S10-12AFM042A	RP12AFM050210S10-12AFM052A
	PUR	RP12AFM030210R10-12AFM032A	RP12AFM040210R10-12AFM042A	RP12AFM050210R10-12AFM052A
	shielded	RP12AFM030210P10-12AFM032A	RP12AFM040210P10-12AFM042A	RP12AFM050210P10-12AFM052A
2 meter	PVC	RP12AFM030220C10-12AFM032A	RP12AFM040220C10-12AFM042A	RP12AFM050220C10-12AFM052A
	shielded	RP12AFM030220S10-12AFM032A	RP12AFM040220S10-12AFM042A	RP12AFM050220S10-12AFM052A
	PUR	RP12AFM030220R10-12AFM032A	RP12AFM040220R10-12AFM042A	RP12AFM050220R10-12AFM052A
	shielded	RP12AFM030220P10-12AFM032A	RP12AFM040220P10-12AFM042A	RP12AFM050220P10-12AFM052A
3 meter	PVC	RP12AFM030230C10-12AFM032A	RP12AFM040230C10-12AFM042A	RP12AFM050230C10-12AFM052A
	shielded	RP12AFM030230S10-12AFM032A	RP12AFM040230S10-12AFM042A	RP12AFM050230S10-12AFM052A
	PUR	RP12AFM030230R10-12AFM032A	RP12AFM040230R10-12AFM042A	RP12AFM050230R10-12AFM052A
	shielded	RP12AFM030230P10-12AFM032A	RP12AFM040230P10-12AFM042A	RP12AFM050230P10-12AFM052A
5 meter	PVC	RP12AFM030250C10-12AFM032A	RP12AFM040250C10-12AFM042A	RP12AFM050250C10-12AFM052A
	shielded	RP12AFM030250S10-12AFM032A	RP12AFM040250S10-12AFM042A	RP12AFM050250S10-12AFM052A
	PUR	RP12AFM030250R10-12AFM032A	RP12AFM040250R10-12AFM042A	RP12AFM050250R10-12AFM052A
	shielded	RP12AFM030250P10-12AFM032A	RP12AFM040250P10-12AFM042A	RP12AFM050250P10-12AFM052A
10 meter	PVC	RP12AFM03020AC10-12AFM032A	RP12AFM04020AC10-12AFM042A	RP12AFM05020AC10-12AFM052A
	shielded	RP12AFM03020AS10-12AFM032A	RP12AFM04020AS10-12AFM042A	RP12AFM05020AS10-12AFM052A
	PUR	RP12AFM03020AR10-12AFM032A	RP12AFM04020AR10-12AFM042A	RP12AFM05020AR10-12AFM052A
	shielded	RP12AFM03020AP10-12AFM032A	RP12AFM04020AP10-12AFM042A	RP12AFM05020AP10-12AFM052A

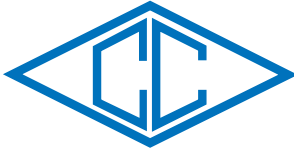

**canfield  
connector**

**CANFast**<sup>®</sup>  
round connectors

**M12 to M12 SERIES**  
12MM MALE STRAIGHT TO  
12MM MALE 90°  
RP MOLDED PATCH CORDS

## DIMENSIONAL DATA

All dimensions are in millimeters unless otherwise noted.

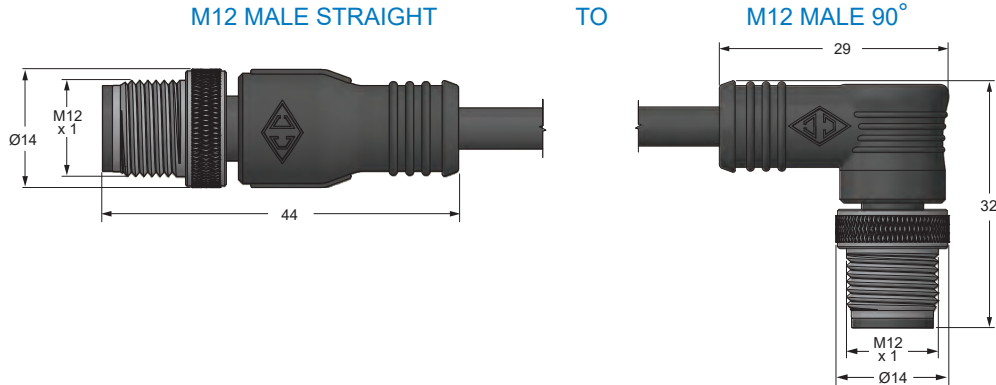

### M12 STRAIGHT PIN CONFIGURATION

**3 Pin  
Male**



Pin 1 = Brown  
Pin 3 = Blue  
Pin 4 = Black

**4 Pin  
Male**



Pin 1 = Brown  
Pin 2 = White  
Pin 3 = Blue  
Pin 4 = Black

**5 Pin  
Male**



Pin 1 = Brown  
Pin 2 = White  
Pin 3 = Blue  
Pin 4 = Black  
Pin 5 = Gray

### M12 90° PIN CONFIGURATION

**3 Pin  
Male**



Pin 1 = Brown  
Pin 3 = Blue  
Pin 4 = Black

**4 Pin  
Male**



Pin 1 = Brown  
Pin 2 = White  
Pin 3 = Blue  
Pin 4 = Black

**5 Pin  
Male**



Pin 1 = Brown  
Pin 2 = White  
Pin 3 = Blue  
Pin 4 = Black  
Pin 5 = Gray

## ORDERING INFORMATION

Consult Factory for stock availability.

### M12 MALE STRAIGHT TO M12 MALE 90°

Length	Wire Type	3 Pin	4 Pin	5 Pin
1 meter	PVC	RP12AMM030110C10-12AMM032A	RP12AMM040110C10-12AMM042A	RP12AMM050110C10-12AMM052A
	shielded	RP12AMM030110S10-12AMM032A	RP12AMM040110S10-12AMM042A	RP12AMM050110S10-12AMM052A
	PUR	RP12AMM030110R10-12AMM032A	RP12AMM040110R10-12AMM042A	RP12AMM050110R10-12AMM052A
	shielded	RP12AMM030110P10-12AMM032A	RP12AMM040110P10-12AMM042A	RP12AMM050110P10-12AMM052A
2 meter	PVC	RP12AMM030120C10-12AMM032A	RP12AMM040120C10-12AMM042A	RP12AMM050120C10-12AMM052A
	shielded	RP12AMM030120S10-12AMM032A	RP12AMM040120S10-12AMM042A	RP12AMM050120S10-12AMM052A
	PUR	RP12AMM030120R10-12AMM032A	RP12AMM040120R10-12AMM042A	RP12AMM050120R10-12AMM052A
	shielded	RP12AMM030120P10-12AMM032A	RP12AMM040120P10-12AMM042A	RP12AMM050120P10-12AMM052A
3 meter	PVC	RP12AMM030130C10-12AMM032A	RP12AMM040130C10-12AMM042A	RP12AMM050130C10-12AMM052A
	shielded	RP12AMM030130S10-12AMM032A	RP12AMM040130S10-12AMM042A	RP12AMM050130S10-12AMM052A
	PUR	RP12AMM030130R10-12AMM032A	RP12AMM040130R10-12AMM042A	RP12AMM050130R10-12AMM052A
	shielded	RP12AMM030130P10-12AMM032A	RP12AMM040130P10-12AMM042A	RP12AMM050130P10-12AMM052A
5 meter	PVC	RP12AMM030150C10-12AMM032A	RP12AMM040150C10-12AMM042A	RP12AMM050150C10-12AMM052A
	shielded	RP12AMM030150S10-12AMM032A	RP12AMM040150S10-12AMM042A	RP12AMM050150S10-12AMM052A
	PUR	RP12AMM030150R10-12AMM032A	RP12AMM040150R10-12AMM042A	RP12AMM050150R10-12AMM052A
	shielded	RP12AMM030150P10-12AMM032A	RP12AMM040150P10-12AMM042A	RP12AMM050150P10-12AMM052A
10 meter	PVC	RP12AMM03010AC10-12AMM032A	RP12AMM04010AC10-12AMM042A	RP12AMM05010AC10-12AMM052A
	shielded	RP12AMM03010AS10-12AMM032A	RP12AMM04010AS10-12AMM042A	RP12AMM05010AS10-12AMM052A
	PUR	RP12AMM03010AR10-12AMM032A	RP12AMM04010AR10-12AMM042A	RP12AMM05010AR10-12AMM052A
	shielded	RP12AMM03010AP10-12AMM032A	RP12AMM04010AP10-12AMM042A	RP12AMM05010AP10-12AMM052A



**canfield  
connector**

**CANFast**<sup>®</sup>  
round connectors

**M12 to M12 SERIES**  
12MM MALE STRAIGHT TO  
12MM FEMALE 90°  
RP MOLDED PATCH CORDS

## DIMENSIONAL DATA

All dimensions are in millimeters unless otherwise noted.

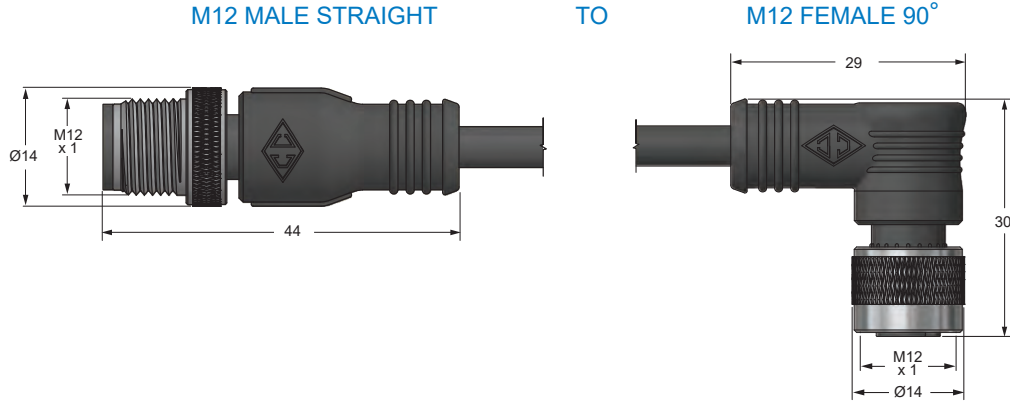

### M12 STRAIGHT PIN CONFIGURATION

**3 Pin  
Male**



Pin 1 = Brown  
Pin 3 = Blue  
Pin 4 = Black

**4 Pin  
Male**



Pin 1 = Brown  
Pin 2 = White  
Pin 3 = Blue  
Pin 4 = Black

**5 Pin  
Male**



Pin 1 = Brown  
Pin 2 = White  
Pin 3 = Blue  
Pin 4 = Black  
Pin 5 = Gray

### M12 90° PIN CONFIGURATION

**3 Pin  
Female**



Pin 1 = Brown  
Pin 3 = Blue  
Pin 4 = Black

**4 Pin  
Female**

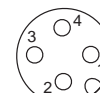

Pin 1 = Brown  
Pin 2 = White  
Pin 3 = Blue  
Pin 4 = Black

**5 Pin  
Female**



Pin 1 = Brown  
Pin 2 = White  
Pin 3 = Blue  
Pin 4 = Black  
Pin 5 = Gray

## ORDERING INFORMATION

Consult Factory for stock availability.

### M12 MALE STRAIGHT TO M12 FEMALE 90°

Length	Wire Type	3 Pin	4 Pin	5 Pin
1 meter	PVC	RP12AMM030110C10-12AFM032A	RP12AMM040110C10-12AFM042A	RP12AMM050110C10-12AFM052A
	shielded	RP12AMM030110S10-12AFM032A	RP12AMM040110S10-12AFM042A	RP12AMM050110S10-12AFM052A
	PUR	RP12AMM030110R10-12AFM032A	RP12AMM040110R10-12AFM042A	RP12AMM050110R10-12AFM052A
	shielded	RP12AMM030110P10-12AFM032A	RP12AMM040110P10-12AFM042A	RP12AMM050110P10-12AFM052A
2 meter	PVC	RP12AMM030120C10-12AFM032A	RP12AMM040120C10-12AFM042A	RP12AMM050120C10-12AFM052A
	shielded	RP12AMM030120S10-12AFM032A	RP12AMM040120S10-12AFM042A	RP12AMM050120S10-12AFM052A
	PUR	RP12AMM030120R10-12AFM032A	RP12AMM040120R10-12AFM042A	RP12AMM050120R10-12AFM052A
	shielded	RP12AMM030120P10-12AFM032A	RP12AMM040120P10-12AFM042A	RP12AMM050120P10-12AFM052A
3 meter	PVC	RP12AMM030130C10-12AFM032A	RP12AMM040130C10-12AFM042A	RP12AMM050130C10-12AFM052A
	shielded	RP12AMM030130S10-12AFM032A	RP12AMM040130S10-12AFM042A	RP12AMM050130S10-12AFM052A
	PUR	RP12AMM030130R10-12AFM032A	RP12AMM040130R10-12AFM042A	RP12AMM050130R10-12AFM052A
	shielded	RP12AMM030130P10-12AFM032A	RP12AMM040130P10-12AFM042A	RP12AMM050130P10-12AFM052A
5 meter	PVC	RP12AMM030150C10-12AFM032A	RP12AMM040150C10-12AFM042A	RP12AMM050150C10-12AFM052A
	shielded	RP12AMM030150S10-12AFM032A	RP12AMM040150S10-12AFM042A	RP12AMM050150S10-12AFM052A
	PUR	RP12AMM030150R10-12AFM032A	RP12AMM040150R10-12AFM042A	RP12AMM050150R10-12AFM052A
	shielded	RP12AMM030150P10-12AFM032A	RP12AMM040150P10-12AFM042A	RP12AMM050150P10-12AFM052A
10 meter	PVC	RP12AMM03010AC10-12AFM032A	RP12AMM04010AC10-12AFM042A	RP12AMM05010AC10-12AFM052A
	shielded	RP12AMM03010AS10-12AFM032A	RP12AMM04010AS10-12AFM042A	RP12AMM05010AS10-12AFM052A
	PUR	RP12AMM03010AR10-12AFM032A	RP12AMM04010AR10-12AFM042A	RP12AMM05010AR10-12AFM052A
	shielded	RP12AMM03010AP10-12AFM032A	RP12AMM04010AP10-12AFM042A	RP12AMM05010AP10-12AFM052A



**canfield  
connector**

**CANFast**<sup>®</sup>  
round connectors

**M12 to M12 SERIES**  
12MM MALE 90° TO  
12MM FEMALE STRAIGHT  
RP MOLDED PATCH CORDS

**DIMENSIONAL DATA**

All dimensions are in millimeters unless otherwise noted.

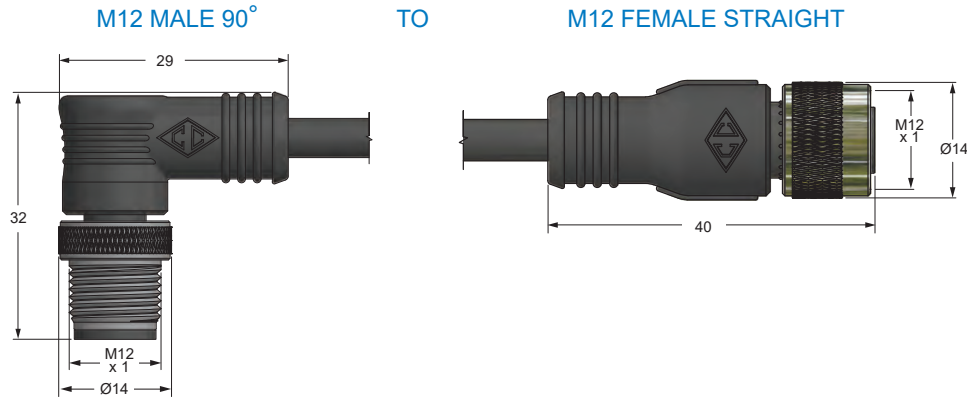

**M12 90° PIN CONFIGURATION**

**M12 STRAIGHT PIN CONFIGURATION**

**3 Pin  
Male**

**4 Pin  
Male**

**5 Pin  
Male**

**3 Pin  
Female**

**4 Pin  
Female**

**5 Pin  
Female**

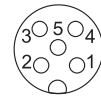
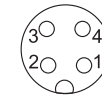
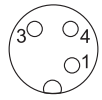
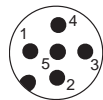
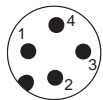
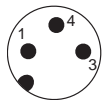

Pin 1 = Brown  
Pin 3 = Blue  
Pin 4 = Black

Pin 1 = Brown  
Pin 2 = White  
Pin 3 = Blue  
Pin 4 = Black

Pin 1 = Brown  
Pin 2 = White  
Pin 3 = Blue  
Pin 4 = Black  
Pin 5 = Gray

Pin 1 = Brown  
Pin 3 = Blue  
Pin 4 = Black

Pin 1 = Brown  
Pin 2 = White  
Pin 3 = Blue  
Pin 4 = Black

Pin 1 = Brown  
Pin 2 = White  
Pin 3 = Blue  
Pin 4 = Black  
Pin 5 = Gray

**ORDERING INFORMATION**

Consult Factory for stock availability.

**M12 MALE 90° TO M12 FEMALE STRAIGHT**

Length	Wire Type	3 Pin	4 Pin	5 Pin
1 meter	PVC	RP12AMM030210C10-12AFM031A	RP12AMM040210C10-12AFM041A	RP12AMM050210C10-12AFM051A
	shielded	RP12AMM030210S10-12AFM031A	RP12AMM040210S10-12AFM041A	RP12AMM050210S10-12AFM051A
	PUR	RP12AMM030210R10-12AFM031A	RP12AMM040210R10-12AFM041A	RP12AMM050210R10-12AFM051A
	shielded	RP12AMM030210P10-12AFM031A	RP12AMM040210P10-12AFM041A	RP12AMM050210P10-12AFM051A
2 meter	PVC	RP12AMM030220C10-12AFM031A	RP12AMM040220C10-12AFM041A	RP12AMM050220C10-12AFM051A
	shielded	RP12AMM030220S10-12AFM031A	RP12AMM040220S10-12AFM041A	RP12AMM050220S10-12AFM051A
	PUR	RP12AMM030220R10-12AFM031A	RP12AMM040220R10-12AFM041A	RP12AMM050220R10-12AFM051A
	shielded	RP12AMM030220P10-12AFM031A	RP12AMM040220P10-12AFM041A	RP12AMM050220P10-12AFM051A
3 meter	PVC	RP12AMM030230C10-12AFM031A	RP12AMM040230C10-12AFM041A	RP12AMM050230C10-12AFM051A
	shielded	RP12AMM030230S10-12AFM031A	RP12AMM040230S10-12AFM041A	RP12AMM050230S10-12AFM051A
	PUR	RP12AMM030230R10-12AFM031A	RP12AMM040230R10-12AFM041A	RP12AMM050230R10-12AFM051A
	shielded	RP12AMM030230P10-12AFM031A	RP12AMM040230P10-12AFM041A	RP12AMM050230P10-12AFM051A
5 meter	PVC	RP12AMM030250C10-12AFM031A	RP12AMM040250C10-12AFM041A	RP12AMM050250C10-12AFM051A
	shielded	RP12AMM030250S10-12AFM031A	RP12AMM040250S10-12AFM041A	RP12AMM050250S10-12AFM051A
	PUR	RP12AMM030250R10-12AFM031A	RP12AMM040250R10-12AFM041A	RP12AMM050250R10-12AFM051A
	shielded	RP12AMM030250P10-12AFM031A	RP12AMM040250P10-12AFM041A	RP12AMM050250P10-12AFM051A
10 meter	PVC	RP12AMM03020AC10-12AFM031A	RP12AMM04020AC10-12AFM041A	RP12AMM05020AC10-12AFM051A
	shielded	RP12AMM03020AS10-12AFM031A	RP12AMM04020AS10-12AFM041A	RP12AMM05020AS10-12AFM051A
	PUR	RP12AMM03020AR10-12AFM031A	RP12AMM04020AR10-12AFM041A	RP12AMM05020AR10-12AFM051A
	shielded	RP12AMM03020AP10-12AFM031A	RP12AMM04020AP10-12AFM041A	RP12AMM05020AP10-12AFM051A

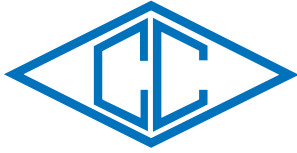

**canfield  
connector**

**CANFast**<sup>®</sup>  
round connectors

**M12 to M12 SERIES**  
12MM FEMALE 90° TO  
12MM FEMALE STRAIGHT  
RP MOLDED PATCH CORDS

## DIMENSIONAL DATA

All dimensions are in millimeters unless otherwise noted.

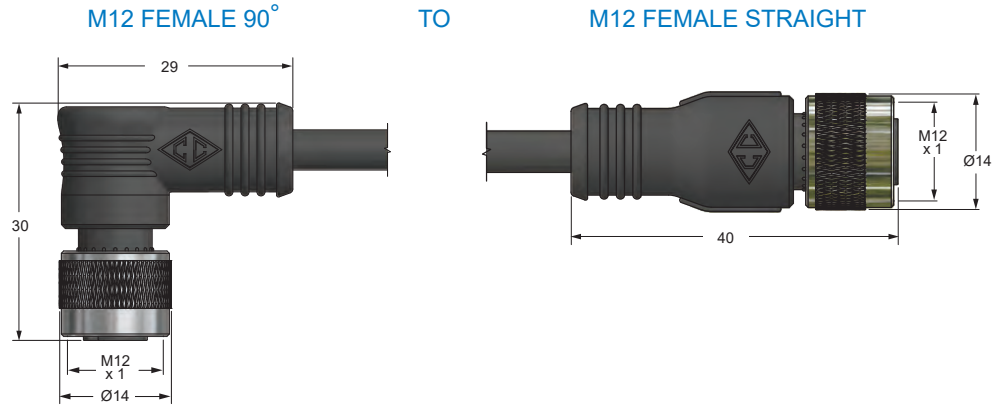

### M12 90° PIN CONFIGURATION

**3 Pin  
Female**

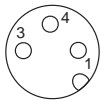

Pin 1 = Brown  
Pin 3 = Blue  
Pin 4 = Black

**4 Pin  
Female**

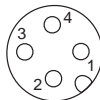

Pin 1 = Brown  
Pin 2 = White  
Pin 3 = Blue  
Pin 4 = Black

**5 Pin  
Female**

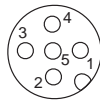

Pin 1 = Brown  
Pin 2 = White  
Pin 3 = Blue  
Pin 4 = Black  
Pin 5 = Gray

### M12 STRAIGHT PIN CONFIGURATION

**3 Pin  
Female**

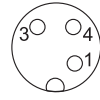

Pin 1 = Brown  
Pin 3 = Blue  
Pin 4 = Black

**4 Pin  
Female**

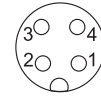

Pin 1 = Brown  
Pin 2 = White  
Pin 3 = Blue  
Pin 4 = Black

**5 Pin  
Female**

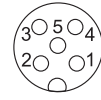

Pin 1 = Brown  
Pin 2 = White  
Pin 3 = Blue  
Pin 4 = Black  
Pin 5 = Gray

## ORDERING INFORMATION

Consult Factory for stock availability.

### M12 FEMALE 90° TO M12 FEMALE STRAIGHT

Length	Wire Type	3 Pin	4 Pin	5 Pin
1 meter	PVC	RP12AFM030210C10-12AFM031A	RP12AFM040210C10-12AFM041A	RP12AFM050210C10-12AFM051A
	shielded	RP12AFM030210S10-12AFM031A	RP12AFM040210S10-12AFM041A	RP12AFM050210S10-12AFM051A
	PUR	RP12AFM030210R10-12AFM031A	RP12AFM040210R10-12AFM041A	RP12AFM050210R10-12AFM051A
	shielded	RP12AFM030210P10-12AFM031A	RP12AFM040210P10-12AFM041A	RP12AFM050210P10-12AFM051A
2 meter	PVC	RP12AFM030220C10-12AFM031A	RP12AFM040220C10-12AFM041A	RP12AFM050220C10-12AFM051A
	shielded	RP12AFM030220S10-12AFM031A	RP12AFM040220S10-12AFM041A	RP12AFM050220S10-12AFM051A
	PUR	RP12AFM030220R10-12AFM031A	RP12AFM040220R10-12AFM041A	RP12AFM050220R10-12AFM051A
	shielded	RP12AFM030220P10-12AFM031A	RP12AFM040220P10-12AFM041A	RP12AFM050220P10-12AFM051A
3 meter	PVC	RP12AFM030230C10-12AFM031A	RP12AFM040230C10-12AFM041A	RP12AFM050230C10-12AFM051A
	shielded	RP12AFM030230S10-12AFM031A	RP12AFM040230S10-12AFM041A	RP12AFM050230S10-12AFM051A
	PUR	RP12AFM030230R10-12AFM031A	RP12AFM040230R10-12AFM041A	RP12AFM050230R10-12AFM051A
	shielded	RP12AFM030230P10-12AFM031A	RP12AFM040230P10-12AFM041A	RP12AFM050230P10-12AFM051A
5 meter	PVC	RP12AFM030250C10-12AFM031A	RP12AFM040250C10-12AFM041A	RP12AFM050250C10-12AFM051A
	shielded	RP12AFM030250S10-12AFM031A	RP12AFM040250S10-12AFM041A	RP12AFM050250S10-12AFM051A
	PUR	RP12AFM030250R10-12AFM031A	RP12AFM040250R10-12AFM041A	RP12AFM050250R10-12AFM051A
	shielded	RP12AFM030250P10-12AFM031A	RP12AFM040250P10-12AFM041A	RP12AFM050250P10-12AFM051A
10 meter	PVC	RP12AFM03020AC10-12AFM031A	RP12AFM04020AC10-12AFM041A	RP12AFM05020AC10-12AFM051A
	shielded	RP12AFM03020AS10-12AFM031A	RP12AFM04020AS10-12AFM041A	RP12AFM05020AS10-12AFM051A
	PUR	RP12AFM03020AR10-12AFM031A	RP12AFM04020AR10-12AFM041A	RP12AFM05020AR10-12AFM051A
	shielded	RP12AFM03020AP10-12AFM031A	RP12AFM04020AP10-12AFM041A	RP12AFM05020AP10-12AFM051A





**canfield  
connector**

**CANFast**  
round connectors

**M8 to M12 SERIES**  
8MM MALE STRAIGHT TO  
12MM FEMALE STRAIGHT  
RP MOLDED PATCH CORDS

## DIMENSIONAL DATA

All dimensions are in millimeters unless otherwise noted.

M8 MALE STRAIGHT

TO

M12 FEMALE STRAIGHT

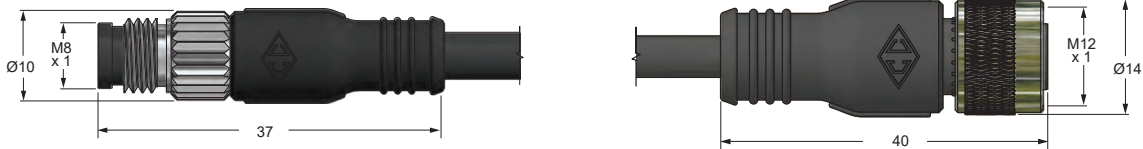

M8 STRAIGHT PIN CONFIGURATION

**3 Pin**

Male



Pin 1 = Brown  
Pin 3 = Blue  
Pin 4 = Black

**4 Pin**

Male



Pin 1 = Brown  
Pin 2 = White  
Pin 3 = Blue  
Pin 4 = Black

M12 STRAIGHT PIN CONFIGURATION

**3 Pin**

Female



Pin 1 = Brown  
Pin 3 = Blue  
Pin 4 = Black

**4 Pin**

Female



Pin 1 = Brown  
Pin 2 = White  
Pin 3 = Blue  
Pin 4 = Black

## ORDERING INFORMATION

Consult Factory for stock availability.

M8 MALE STRAIGHT TO M12 FEMALE STRAIGHT

Length	Wire Type	3 Pin	4 Pin
1 meter	PVC	RP08AMM030110C10-12AFM031A	RP08AMM040110C10-12AFM031A
	shielded	RP08AMM030110S10-12AFM031A	RP08AMM040110S10-12AFM031A
	PUR	RP08AMM030110R10-12AFM031A	RP08AMM040110R10-12AFM031A
	shielded	RP08AMM030110P10-12AFM031A	RP08AMM040110P10-12AFM031A
2 meter	PVC	RP08AMM030120C10-12AFM031A	RP08AMM040120C10-12AFM031A
	shielded	RP08AMM030120S10-12AFM031A	RP08AMM040120S10-12AFM031A
	PUR	RP08AMM030120R10-12AFM031A	RP08AMM040120R10-12AFM031A
	shielded	RP08AMM030120P10-12AFM031A	RP08AMM040120P10-12AFM031A
3 meter	PVC	RP08AMM030130C10-12AFM031A	RP08AMM040130C10-12AFM031A
	shielded	RP08AMM030130S10-12AFM031A	RP08AMM040130S10-12AFM031A
	PUR	RP08AMM030130R10-12AFM031A	RP08AMM040130R10-12AFM031A
	shielded	RP08AMM030130P10-12AFM031A	RP08AMM040130P10-12AFM031A
5 meter	PVC	RP08AMM030150C10-12AFM031A	RP08AMM040150C10-12AFM031A
	shielded	RP08AMM030150S10-12AFM031A	RP08AMM040150S10-12AFM031A
	PUR	RP08AMM030150R10-12AFM031A	RP08AMM040150R10-12AFM031A
	shielded	RP08AMM030150P10-12AFM031A	RP08AMM040150P10-12AFM031A
10 meter	PVC	RP08AMM03010AC10-12AFM031A	RP08AMM04010AC10-12AFM031A
	shielded	RP08AMM03010AS10-12AFM031A	RP08AMM04010AS10-12AFM031A
	PUR	RP08AMM03010AR10-12AFM031A	RP08AMM04010AR10-12AFM031A
	shielded	RP08AMM03010AP10-12AFM031A	RP08AMM04010AP10-12AFM031A



**canfield  
connector**

**CANFast**<sup>®</sup>  
round connectors

**M8 to M12 SERIES**  
8MM MALE STRAIGHT TO  
12MM FEMALE 90°  
RP MOLDED PATCH CORDS

## DIMENSIONAL DATA

All dimensions are in millimeters unless otherwise noted.

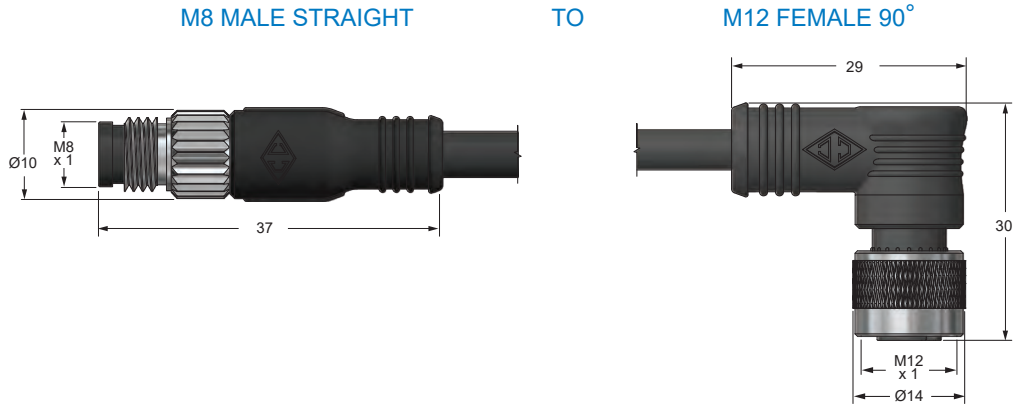

### M8 STRAIGHT PIN CONFIGURATION

#### 3 Pin

Male



Pin 1 = Brown  
Pin 3 = Blue  
Pin 4 = Black

#### 4 Pin

Male



Pin 1 = Brown  
Pin 2 = White  
Pin 3 = Blue  
Pin 4 = Black

### M12 90° PIN CONFIGURATION

#### 3 Pin

Female



Pin 1 = Brown  
Pin 3 = Blue  
Pin 4 = Black

#### 4 Pin

Female

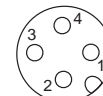

Pin 1 = Brown  
Pin 2 = White  
Pin 3 = Blue  
Pin 4 = Black

## ORDERING INFORMATION

Consult Factory for stock availability.

### M8 MALE STRAIGHT TO M12 FEMALE 90°

Length	Wire Type	3 Pin	4 Pin
1 meter	PVC	RP08AMM030110C10-12AFM032A	RP08AMM040110C10-12AFM032A
	shielded	RP08AMM030110S10-12AFM032A	RP08AMM040110S10-12AFM032A
	PUR	RP08AMM030110R10-12AFM032A	RP08AMM040110R10-12AFM032A
	shielded	RP08AMM030110P10-12AFM032A	RP08AMM040110P10-12AFM032A
2 meter	PVC	RP08AMM030120C10-12AFM032A	RP08AMM040120C10-12AFM032A
	shielded	RP08AMM030120S10-12AFM032A	RP08AMM040120S10-12AFM032A
	PUR	RP08AMM030120R10-12AFM032A	RP08AMM040120R10-12AFM032A
	shielded	RP08AMM030120P10-12AFM032A	RP08AMM040120P10-12AFM032A
3 meter	PVC	RP08AMM030130C10-12AFM032A	RP08AMM040130C10-12AFM032A
	shielded	RP08AMM030130S10-12AFM032A	RP08AMM040130S10-12AFM032A
	PUR	RP08AMM030130R10-12AFM032A	RP08AMM040130R10-12AFM032A
	shielded	RP08AMM030130P10-12AFM032A	RP08AMM040130P10-12AFM032A
5 meter	PVC	RP08AMM030150C10-12AFM032A	RP08AMM040150C10-12AFM032A
	shielded	RP08AMM030150S10-12AFM032A	RP08AMM040150S10-12AFM032A
	PUR	RP08AMM030150R10-12AFM032A	RP08AMM040150R10-12AFM032A
	shielded	RP08AMM030150P10-12AFM032A	RP08AMM040150P10-12AFM032A
10 meter	PVC	RP08AMM03010AC10-12AFM032A	RP08AMM04010AC10-12AFM032A
	shielded	RP08AMM03010AS10-12AFM032A	RP08AMM04010AS10-12AFM032A
	PUR	RP08AMM03010AR10-12AFM032A	RP08AMM04010AR10-12AFM032A
	shielded	RP08AMM03010AP10-12AFM032A	RP08AMM04010AP10-12AFM032A



**canfield  
connector**

**CANFast**  
round connectors

**M12 to M8 SERIES**  
12MM MALE STRAIGHT TO  
8MM MALE STRAIGHT  
RP MOLDED PATCH CORDS

## DIMENSIONAL DATA

All dimensions are in millimeters unless otherwise noted.

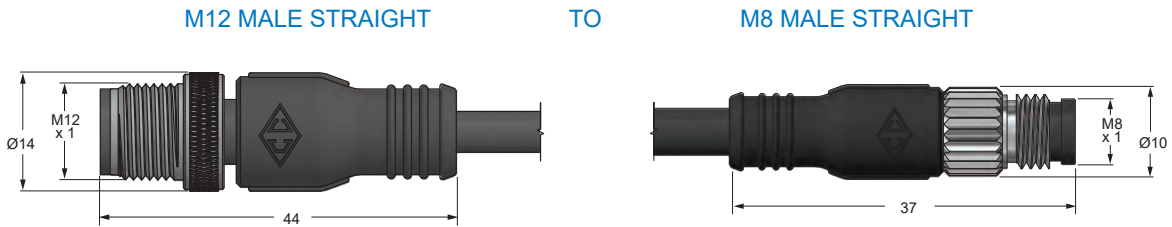

### M12 STRAIGHT PIN CONFIGURATION

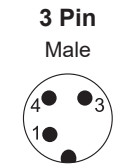

Pin 1 = Brown  
Pin 3 = Blue  
Pin 4 = Black

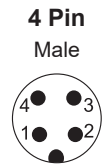

Pin 1 = Brown  
Pin 2 = White  
Pin 3 = Blue  
Pin 4 = Black

### M8 STRAIGHT PIN CONFIGURATION



Pin 1 = Brown  
Pin 3 = Blue  
Pin 4 = Black



Pin 1 = Brown  
Pin 2 = White  
Pin 3 = Blue  
Pin 4 = Black

## ORDERING INFORMATION

Consult Factory for stock availability.

### M12 MALE STRAIGHT TO M8 MALE STRAIGHT

Length	Wire Type	3 Pin	4 Pin
1 meter	PVC	RP12AMM030110C10-08AMM031A	RP12AMM040110C10-08AMM041A
	shielded	RP12AMM030110S10-08AMM031A	RP12AMM040110S10-08AMM041A
	PUR	RP12AMM030110R10-08AMM031A	RP12AMM040110R10-08AMM041A
	shielded	RP12AMM030110P10-08AMM031A	RP12AMM040110P10-08AMM041A
2 meter	PVC	RP12AMM030120C10-08AMM031A	RP12AMM040120C10-08AMM041A
	shielded	RP12AMM030120S10-08AMM031A	RP12AMM040120S10-08AMM041A
	PUR	RP12AMM030120R10-08AMM031A	RP12AMM040120R10-08AMM041A
	shielded	RP12AMM030120P10-08AMM031A	RP12AMM040120P10-08AMM041A
3 meter	PVC	RP12AMM030130C10-08AMM031A	RP12AMM040130C10-08AMM041A
	shielded	RP12AMM030130S10-08AMM031A	RP12AMM040130S10-08AMM041A
	PUR	RP12AMM030130R10-08AMM031A	RP12AMM040130R10-08AMM041A
	shielded	RP12AMM030130P10-08AMM031A	RP12AMM040130P10-08AMM041A
5 meter	PVC	RP12AMM030150C10-08AMM031A	RP12AMM040150C10-08AMM041A
	shielded	RP12AMM030150S10-08AMM031A	RP12AMM040150S10-08AMM041A
	PUR	RP12AMM030150R10-08AMM031A	RP12AMM040150R10-08AMM041A
	shielded	RP12AMM030150P10-08AMM031A	RP12AMM040150P10-08AMM041A
10 meter	PVC	RP12AMM03010AC10-08AMM031A	RP12AMM04010AC10-08AMM041A
	shielded	RP12AMM03010AS10-08AMM031A	RP12AMM04010AS10-08AMM041A
	PUR	RP12AMM03010AR10-08AMM031A	RP12AMM04010AR10-08AMM041A
	shielded	RP12AMM03010AP10-08AMM031A	RP12AMM04010AP10-08AMM041A



**canfield  
connector**

**CANFast**<sup>®</sup>  
round connectors

**M12 to M8 SERIES**  
12MM MALE STRAIGHT TO  
8MM FEMALE STRAIGHT  
RP MOLDED PATCH CORDS

## DIMENSIONAL DATA

All dimensions are in millimeters unless otherwise noted.

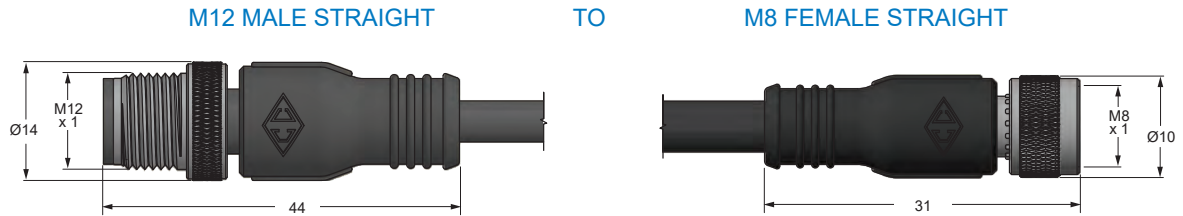

### M12 STRAIGHT PIN CONFIGURATION

**3 Pin**  
Male

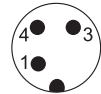

Pin 1 = Brown  
Pin 3 = Blue  
Pin 4 = Black

**4 Pin**  
Male



Pin 1 = Brown  
Pin 2 = White  
Pin 3 = Blue  
Pin 4 = Black

### M8 STRAIGHT PIN CONFIGURATION

**3 Pin**  
Female



Pin 1 = Brown  
Pin 3 = Blue  
Pin 4 = Black

**4 Pin**  
Female



Pin 1 = Brown  
Pin 2 = White  
Pin 3 = Blue  
Pin 4 = Black

## ORDERING INFORMATION

Consult Factory for stock availability.

### M12 MALE STRAIGHT TO M8 FEMALE STRAIGHT

Length	Wire Type	3 Pin	4 Pin
1 meter	PVC	RP12AMM030110C10-08AFM031A	RP12AMM040110C10-08AFM041A
	shielded	RP12AMM030110S10-08AFM031A	RP12AMM040110S10-08AFM041A
	PUR	RP12AMM030110R10-08AFM031A	RP12AMM040110R10-08AFM041A
	shielded	RP12AMM030110P10-08AFM031A	RP12AMM040110P10-08AFM041A
2 meter	PVC	RP12AMM030120C10-08AFM031A	RP12AMM040120C10-08AFM041A
	shielded	RP12AMM030120S10-08AFM031A	RP12AMM040120S10-08AFM041A
	PUR	RP12AMM030120R10-08AFM031A	RP12AMM040120R10-08AFM041A
	shielded	RP12AMM030120P10-08AFM031A	RP12AMM040120P10-08AFM041A
3 meter	PVC	RP12AMM030130C10-08AFM031A	RP12AMM040130C10-08AFM041A
	shielded	RP12AMM030130S10-08AFM031A	RP12AMM040130S10-08AFM041A
	PUR	RP12AMM030130R10-08AFM031A	RP12AMM040130R10-08AFM041A
	shielded	RP12AMM030130P10-08AFM031A	RP12AMM040130P10-08AFM041A
5 meter	PVC	RP12AMM030150C10-08AFM031A	RP12AMM040150C10-08AFM041A
	shielded	RP12AMM030150S10-08AFM031A	RP12AMM040150S10-08AFM041A
	PUR	RP12AMM030150R10-08AFM031A	RP12AMM040150R10-08AFM041A
	shielded	RP12AMM030150P10-08AFM031A	RP12AMM040150P10-08AFM041A
10 meter	PVC	RP12AMM03010AC10-08AFM031A	RP12AMM04010AC10-08AFM041A
	shielded	RP12AMM03010AS10-08AFM031A	RP12AMM04010AS10-08AFM041A
	PUR	RP12AMM03010AR10-08AFM031A	RP12AMM04010AR10-08AFM041A
	shielded	RP12AMM03010AP10-08AFM031A	RP12AMM04010AP10-08AFM041A

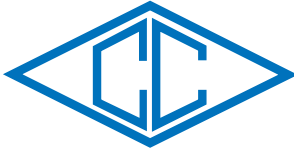

**canfield  
connector**

**CANFast**  
round connectors

**M12 to M8 SERIES**  
12MM FEMALE STRAIGHT TO  
8MM FEMALE STRAIGHT  
RP MOLDED PATCH CORDS

## DIMENSIONAL DATA

All dimensions are in millimeters unless otherwise noted.

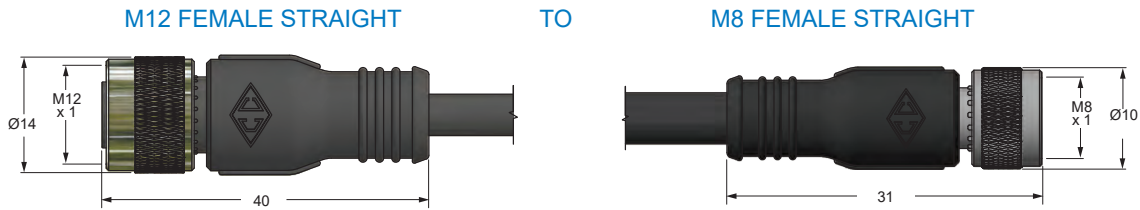

### M12 STRAIGHT PIN CONFIGURATION

**3 Pin  
Female**



Pin 1 = Brown  
Pin 3 = Blue  
Pin 4 = Black

**4 Pin  
Female**



Pin 1 = Brown  
Pin 2 = White  
Pin 3 = Blue  
Pin 4 = Black

### M8 STRAIGHT PIN CONFIGURATION

**3 Pin  
Female**



Pin 1 = Brown  
Pin 3 = Blue  
Pin 4 = Black

**4 Pin  
Female**



Pin 1 = Brown  
Pin 2 = White  
Pin 3 = Blue  
Pin 4 = Black

## ORDERING INFORMATION

Consult Factory for stock availability.

### M12 FEMALE STRAIGHT TO M8 FEMALE STRAIGHT

Length	Wire Type	3 Pin	4 Pin
1 meter	PVC	RP12AFM030110C10-08AFM031A	RP12AFM040110C10-08AFM041A
	shielded	RP12AFM030110S10-08AFM031A	RP12AFM040110S10-08AFM041A
	PUR	RP12AFM030110R10-08AFM031A	RP12AFM040110R10-08AFM041A
	shielded	RP12AFM030110P10-08AFM031A	RP12AFM040110P10-08AFM041A
2 meter	PVC	RP12AFM030120C10-08AFM031A	RP12AFM040120C10-08AFM041A
	shielded	RP12AFM030120S10-08AFM031A	RP12AFM040120S10-08AFM041A
	PUR	RP12AFM030120R10-08AFM031A	RP12AFM040120R10-08AFM041A
	shielded	RP12AFM030120P10-08AFM031A	RP12AFM040120P10-08AFM041A
3 meter	PVC	RP12AFM030130C10-08AFM031A	RP12AFM040130C10-08AFM041A
	shielded	RP12AFM030130S10-08AFM031A	RP12AFM040130S10-08AFM041A
	PUR	RP12AFM030130R10-08AFM031A	RP12AFM040130R10-08AFM041A
	shielded	RP12AFM030130P10-08AFM031A	RP12AFM040130P10-08AFM041A
5 meter	PVC	RP12AFM030150C10-08AFM031A	RP12AFM040150C10-08AFM041A
	shielded	RP12AFM030150S10-08AFM031A	RP12AFM040150S10-08AFM041A
	PUR	RP12AFM030150R10-08AFM031A	RP12AFM040150R10-08AFM041A
	shielded	RP12AFM030150P10-08AFM031A	RP12AFM040150P10-08AFM041A
10 meter	PVC	RP12AFM03010AC10-08AFM031A	RP12AFM04010AC10-08AFM041A
	shielded	RP12AFM03010AS10-08AFM031A	RP12AFM04010AS10-08AFM041A
	PUR	RP12AFM03010AR10-08AFM031A	RP12AFM04010AR10-08AFM041A
	shielded	RP12AFM03010AP10-08AFM031A	RP12AFM04010AP10-08AFM041A



**canfield  
connector**

**CANFast**<sup>®</sup>  
round connectors

**M12 to M8 SERIES**  
12MM MALE 90° TO  
8MM MALE STRAIGHT  
RP MOLDED PATCH CORDS

## DIMENSIONAL DATA

All dimensions are in millimeters unless otherwise noted.

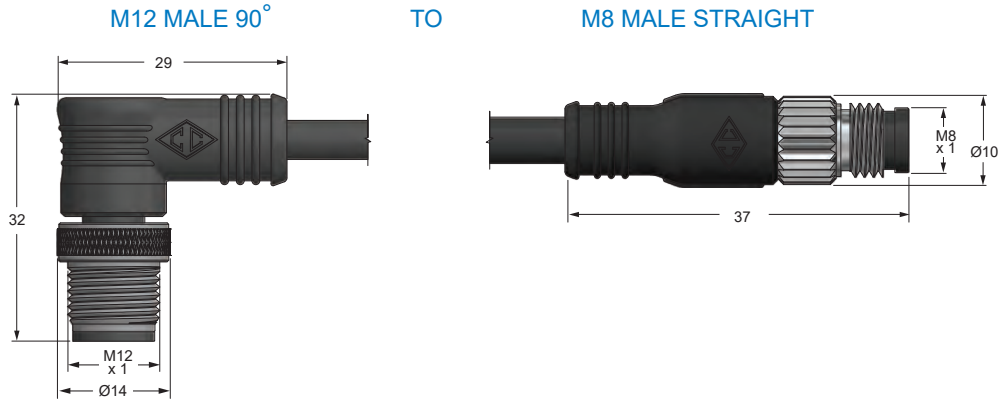

### M12 90° PIN CONFIGURATION

**3 Pin**  
Male

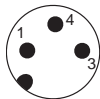

Pin 1 = Brown  
Pin 3 = Blue  
Pin 4 = Black

**4 Pin**  
Male



Pin 1 = Brown  
Pin 2 = White  
Pin 3 = Blue  
Pin 4 = Black

### M8 STRAIGHT PIN CONFIGURATION

**3 Pin**  
Male



Pin 1 = Brown  
Pin 3 = Blue  
Pin 4 = Black

**4 Pin**  
Male



Pin 1 = Brown  
Pin 2 = White  
Pin 3 = Blue  
Pin 4 = Black

## ORDERING INFORMATION

Consult Factory for stock availability.

### M12 MALE 90° TO M8 MALE STRAIGHT

Length	Wire Type	3 Pin	4 Pin
1 meter	PVC	RP12AMM030210C10-08AMM031A	RP12AMM040210C10-08AMM041A
	shielded	RP12AMM030210S10-08AMM031A	RP12AMM040210S10-08AMM041A
	PUR	RP12AMM030210R10-08AMM031A	RP12AMM040210R10-08AMM041A
	shielded	RP12AMM030210P10-08AMM031A	RP12AMM040210P10-08AMM041A
2 meter	PVC	RP12AMM030220C10-08AMM031A	RP12AMM040220C10-08AMM041A
	shielded	RP12AMM030220S10-08AMM031A	RP12AMM040220S10-08AMM041A
	PUR	RP12AMM030220R10-08AMM031A	RP12AMM040220R10-08AMM041A
	shielded	RP12AMM030220P10-08AMM031A	RP12AMM040220P10-08AMM041A
3 meter	PVC	RP12AMM030230C10-08AMM031A	RP12AMM040230C10-08AMM041A
	shielded	RP12AMM030230S10-08AMM031A	RP12AMM040230S10-08AMM041A
	PUR	RP12AMM030230R10-08AMM031A	RP12AMM040230R10-08AMM041A
	shielded	RP12AMM030230P10-08AMM031A	RP12AMM040230P10-08AMM041A
5 meter	PVC	RP12AMM030250C10-08AMM031A	RP12AMM040250C10-08AMM041A
	shielded	RP12AMM030250S10-08AMM031A	RP12AMM040250S10-08AMM041A
	PUR	RP12AMM030250R10-08AMM031A	RP12AMM040250R10-08AMM041A
	shielded	RP12AMM030250P10-08AMM031A	RP12AMM040250P10-08AMM041A
10 meter	PVC	RP12AMM03020AC10-08AMM031A	RP12AMM04020AC10-08AMM041A
	shielded	RP12AMM03020AS10-08AMM031A	RP12AMM04020AS10-08AMM041A
	PUR	RP12AMM03020AR10-08AMM031A	RP12AMM04020AR10-08AMM041A
	shielded	RP12AMM03020AP10-08AMM031A	RP12AMM04020AP10-08AMM041A



**canfield  
connector**

**CANFast**  
round connectors

**M12 to M8 SERIES**  
12MM MALE 90° TO  
8MM FEMALE STRAIGHT  
RP MOLDED PATCH CORDS

## DIMENSIONAL DATA

All dimensions are in millimeters unless otherwise noted.

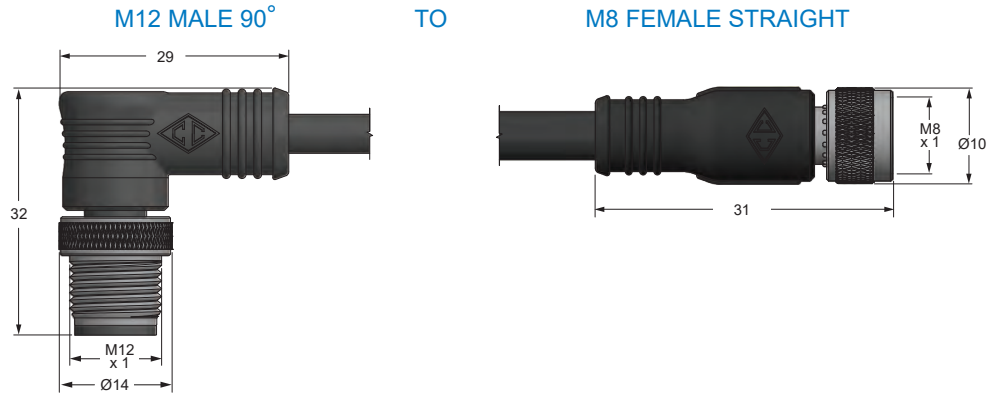

### M12 90° PIN CONFIGURATION

**3 Pin  
Male**

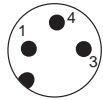

Pin 1 = Brown  
Pin 3 = Blue  
Pin 4 = Black

**4 Pin  
Male**

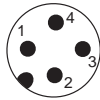

Pin 1 = Brown  
Pin 2 = White  
Pin 3 = Blue  
Pin 4 = Black

### M8 STRAIGHT PIN CONFIGURATION

**3 Pin  
Female**

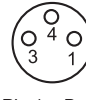

Pin 1 = Brown  
Pin 3 = Blue  
Pin 4 = Black

**4 Pin  
Female**

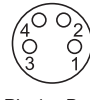

Pin 1 = Brown  
Pin 2 = White  
Pin 3 = Blue  
Pin 4 = Black

## ORDERING INFORMATION

Consult Factory for stock availability.

### M12 MALE 90° TO M8 FEMALE STRAIGHT

Length	Wire Type	3 Pin	4 Pin
1 meter	PVC	RP12AMM030210C10-08AFM031A	RP12AMM040210C10-08AFM041A
	shielded	RP12AMM030210S10-08AFM031A	RP12AMM040210S10-08AFM041A
	PUR	RP12AMM030210R10-08AFM031A	RP12AMM040210R10-08AFM041A
	shielded	RP12AMM030210P10-08AFM031A	RP12AMM040210P10-08AFM041A
2 meter	PVC	RP12AMM030220C10-08AFM031A	RP12AMM040220C10-08AFM041A
	shielded	RP12AMM030220S10-08AFM031A	RP12AMM040220S10-08AFM041A
	PUR	RP12AMM030220R10-08AFM031A	RP12AMM040220R10-08AFM041A
	shielded	RP12AMM030220P10-08AFM031A	RP12AMM040220P10-08AFM041A
3 meter	PVC	RP12AMM030230C10-08AFM031A	RP12AMM040230C10-08AFM041A
	shielded	RP12AMM030230S10-08AFM031A	RP12AMM040230S10-08AFM041A
	PUR	RP12AMM030230R10-08AFM031A	RP12AMM040230R10-08AFM041A
	shielded	RP12AMM030230P10-08AFM031A	RP12AMM040230P10-08AFM041A
5 meter	PVC	RP12AMM030250C10-08AFM031A	RP12AMM040250C10-08AFM041A
	shielded	RP12AMM030250S10-08AFM031A	RP12AMM040250S10-08AFM041A
	PUR	RP12AMM030250R10-08AFM031A	RP12AMM040250R10-08AFM041A
	shielded	RP12AMM030250P10-08AFM031A	RP12AMM040250P10-08AFM041A
10 meter	PVC	RP12AMM03020AC10-08AFM031A	RP12AMM04020AC10-08AFM041A
	shielded	RP12AMM03020AS10-08AFM031A	RP12AMM04020AS10-08AFM041A
	PUR	RP12AMM03020AR10-08AFM031A	RP12AMM04020AR10-08AFM041A
	shielded	RP12AMM03020AP10-08AFM031A	RP12AMM04020AP10-08AFM041A

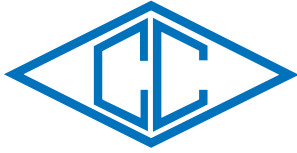

**canfield  
connector**

**CANFast**<sup>®</sup>  
round connectors

**M12 to M8 SERIES**  
12MM FEMALE 90° TO  
8MM FEMALE STRAIGHT  
RP MOLDED PATCH CORDS

## DIMENSIONAL DATA

All dimensions are in millimeters unless otherwise noted.

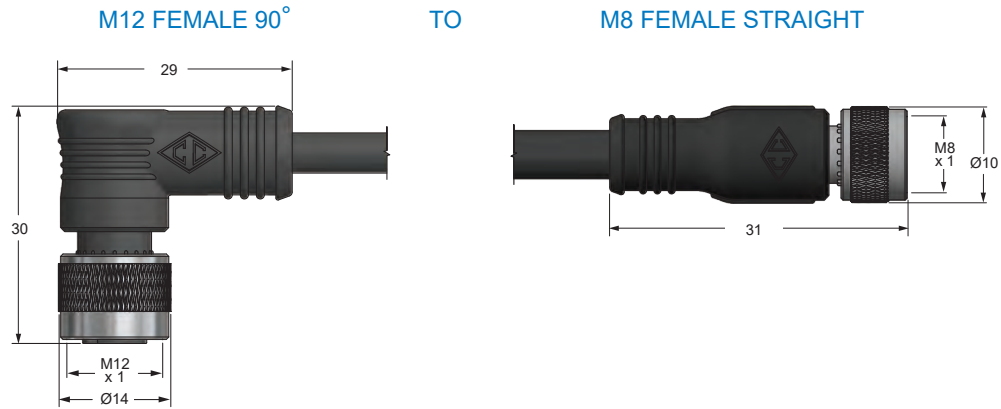

### M12 90° PIN CONFIGURATION

**3 Pin  
Female**

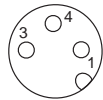

Pin 1 = Brown  
Pin 3 = Blue  
Pin 4 = Black

**4 Pin  
Female**

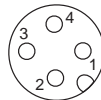

Pin 1 = Brown  
Pin 2 = White  
Pin 3 = Blue  
Pin 4 = Black

### M8 STRAIGHT PIN CONFIGURATION

**3 Pin  
Female**



Pin 1 = Brown  
Pin 3 = Blue  
Pin 4 = Black

**4 Pin  
Female**



Pin 1 = Brown  
Pin 2 = White  
Pin 3 = Blue  
Pin 4 = Black

## ORDERING INFORMATION

Consult Factory for stock availability.

### M12 FEMALE 90° TO M8 FEMALE STRAIGHT

Length	Wire Type	3 Pin	4 Pin
1 meter	PVC	RP12AFM030210C10-08AFM031A	RP12AFM040210C10-08AFM041A
	shielded	RP12AFM030210S10-08AFM031A	RP12AFM040210S10-08AFM041A
	PUR	RP12AFM030210R10-08AFM031A	RP12AFM040210R10-08AFM041A
	shielded	RP12AFM030210P10-08AFM031A	RP12AFM040210P10-08AFM041A
2 meter	PVC	RP12AFM030220C10-08AFM031A	RP12AFM040220C10-08AFM041A
	shielded	RP12AFM030220S10-08AFM031A	RP12AFM040220S10-08AFM041A
	PUR	RP12AFM030220R10-08AFM031A	RP12AFM040220R10-08AFM041A
	shielded	RP12AFM030220P10-08AFM031A	RP12AFM040220P10-08AFM041A
3 meter	PVC	RP12AFM030230C10-08AFM031A	RP12AFM040230C10-08AFM041A
	shielded	RP12AFM030230S10-08AFM031A	RP12AFM040230S10-08AFM041A
	PUR	RP12AFM030230R10-08AFM031A	RP12AFM040230R10-08AFM041A
	shielded	RP12AFM030230P10-08AFM031A	RP12AFM040230P10-08AFM041A
5 meter	PVC	RP12AFM030250C10-08AFM031A	RP12AFM040250C10-08AFM041A
	shielded	RP12AFM030250S10-08AFM031A	RP12AFM040250S10-08AFM041A
	PUR	RP12AFM030250R10-08AFM031A	RP12AFM040250R10-08AFM041A
	shielded	RP12AFM030250P10-08AFM031A	RP12AFM040250P10-08AFM041A
10 meter	PVC	RP12AFM03020AC10-08AFM031A	RP12AFM04020AC10-08AFM041A
	shielded	RP12AFM03020AS10-08AFM031A	RP12AFM04020AS10-08AFM041A
	PUR	RP12AFM03020AR10-08AFM031A	RP12AFM04020AR10-08AFM041A
	shielded	RP12AFM03020AP10-08AFM031A	RP12AFM04020AP10-08AFM041A





*We appreciate your business!*

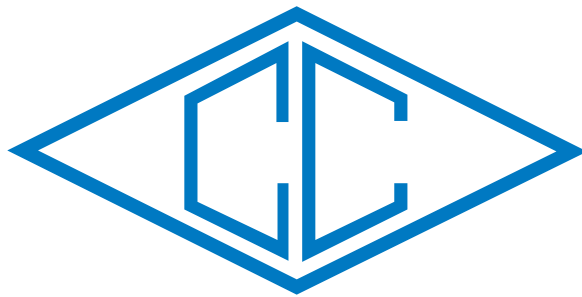

## **canfield connector**

8510 Foxwood Court ♦ Youngstown, OH 44514

**1-800-554-5071**

Ph:(330)758-8299 ♦ Fx:(330)758-8912

[www.canfieldconnector.com](http://www.canfieldconnector.com)

