



canfield
connector

Magnetic ♦ Proximity ♦ Angle ♦ Tilt

SENSORS



canfield connector

www.canfieldconnector.com

www.mfcp.com

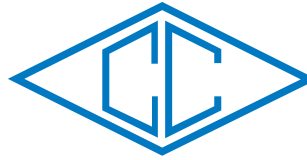

canfield connector

Quality is our goal.

Canfield Connector is a manufacturer of interconnection devices, electronic timers, modules and specialty electronic devices targeted at the fluid power industry. Our *Complete Quality Control Program (CQCP)* protects our customers by assuring them of 100% test and inspection prior to shipment of all items produced at Canfield Connector. Most items are tested during the manufacturing process and again during final inspection, making our products double or triple tested for function prior to shipment. Our Quality Policy at Canfield Industries is: Total Customer Satisfaction Through Unmatched Quality, Products, Service, and Integrity. Our Quality Objectives are Customer Satisfaction, On-Time Delivery, Sales and Profit Growth, High Quality Products, and Superior Supplier Performance. Canfield Connector operations have been certified to the ISO 9001 With Design International Quality System Standard.

1 year warranty

All products manufactured by Canfield Connector are warranted by Canfield Connector to be free of defects in material and workmanship for a period of one year from the purchase date. Canfield Connector's obligation under this warranty is limited to repair or replacement of the defective product or refund of the purchase price paid solely at the discretion of Canfield Connector and provided such defective product is returned to Canfield Connector freight prepaid and upon examination by Canfield Connector such product is found defective. This warranty shall be void in the event that the product has been subject to misuse, misapplication, improper maintenance, or tampering. This warranty is expressed in lieu of all other warranties, expressed or implied from Canfield Connector representatives or employees.

Designs and published data

All designs and specifications are subject to change without notice. Such changes are not to be considered retroactive, and seller assumes no responsibility for revision of models already in the field. All data is sufficiently accurate for general use, but seller assumes no responsibility for errors or omissions. Certified prints are available on request, at a reasonable charge.



Technical assistance

Our trained technical staff is available to help you with your questions concerning Canfield products. All questions are welcome. We are constantly developing new product lines and custom products for different applications. Ask our sales representative for more details. Call: (330) 758-8299 or 1-800-554-5071 Email: customerservice@canfieldconnector.com

Ordering made easy

Our friendly Customer Service Team is available to take your order 8:00 AM to 5:00 PM EST Monday through Friday. Call: (330)758-8299 or Toll Free: 1-800-554-5071 Fax: (330)758-8912 Email: customerservice@canfieldconnector.com



Youngstown, Ohio U.S.A.

DISCLAIMER

Product changes including specifications, features, designs, and availability are subject to change anytime without notice. For critical dimensions or specifications, contact factory.

Canfield Industries, Inc.



ISO 9001:2015
with design
Cert # 05.096.1



www.canfieldconnector.com ◆ [em: customerservice@canfieldconnector.com](mailto:customerservice@canfieldconnector.com) ◆ [ph: 1-800-554-5071](tel:1-800-554-5071)

www.mfcp.com

Canfield Connector

8510 Foxwood Court • Youngstown, OH 44514

STANDARD TERMS OF SALE AND RESTOCKING

1. GENERAL:

- a.) This contract contains the entire agreement between parties and supersedes any prior or contemporaneous oral or written agreements or communications between them relating to the subject matter hereof.
- b.) This contract may not be assigned, modified or cancelled without Seller's prior written consent, and any attempt to assign, modify or cancel it without consent shall be absolutely void.
- c.) No delay or omission to exercise any right, per or remedy accruing to Seller upon breach or default by Buyer under this contract shall impair any such right, power or remedy of Seller, or shall be construed as a waiver of any such breach or default. All waivers must be in writing.
- d.) In the event of any of the provisions hereof shall, for any reason, be held void or unenforceable, the remaining provisions shall remain in full force and effect and shall control.
- e.) Any provisions of this contract prohibited by law of any state shall as to said state, be ineffective to the extent of such prohibition without invalidating the remaining provisions of this contract.
- f.) This contract shall be governed by and construed in accordance with the laws of the State of Ohio, excluding however, Ohio law pertaining to conflicts of law.

2. SELLER'S LIMITED WARRANTY AND LIMITATIONS OF LIABILITIES:

All goods sold hereunder are warranted to be free from defects in material and workmanship for a period of one (1) year from the date of manufacture unless otherwise agreed upon in writing, and to conform to applicable specifications, drawings, blueprints and/or samples. These express warranties are in lieu of and exclude all other warranties, express or implied. Seller's sole obligation under these warranties shall be to issue credit, repair, or replace any item or part thereof which is proved to be other than as warranted; no allowance shall be made for any labor charges of Buyer for replacement of parts, adjustment or repairs, or any other work, unless such charges are authorized in advance by Seller. If goods are claimed to be defective in material or workmanship or not to conform to specifications, drawings, blueprints and/or samples, Seller upon notice promptly given will either examine the goods at their site, or issue shipping instructions for return to Seller (transportation costs prepaid by Buyer). In the event any goods are proved to be other than as warranted, transportation costs to and from Seller's plant will be borne by Seller and reimbursement or credit will be made for amounts so expended by Buyer. In particular, seller makes no warranty respecting the merchantability of the products or their suitability or fitness for any particular purpose or use or respecting infringement. These warranties shall not extend to any goods or parts thereof which have been subjected to misuse or neglect, damage by accident, rendered defective by reason of improper installation or by the performance of repairs or alterations outside of Seller's plant except when performed under Seller's specific authority. These warranties shall not apply to any goods or parts thereof furnished by Buyer or acquired from others at Buyer's request and/or to Buyer's specifications. BUYER SHALL NOT IN ANY EVENT BE ENTITLED TO, AND SELLER SHALL NOT BE LIABLE FOR INDIRECT, SPECIAL, INCIDENTAL OR CONSEQUENTIAL DAMAGES OF ANY NATURE INCLUDING, WITHOUT BEING LIMITED TO, LOSS OF PROFIT, LOSS OF DATA, LOSS OF USE, PROMOTIONAL OR MANUFACTURING EXPENSES, OVERHEAD, INJURY TO REPUTATION OR LOSS OF CUSTOMERS. BUYER'S RECOVERY FROM SELLER FOR ANY CLAIM SHALL NOT EXCEED BUYER'S PURCHASE PRICE FOR THE PRODUCTS IRRESPECTIVE OF THE NATURE OF THE CLAIM, WHETHER IN CONTRACT, TORT, WARRANTY, OR OTHERWISE.

3. PAYMENT:

- a.) Checks are accepted subject to collection and the date of collection shall be deemed the date of payment. Any check received from Buyer may be applied by Seller against any obligation owing by Buyer to Seller, under this or any other contract, regardless of any statement appearing on or referring to such check, without discharging Buyer's liability for any additional amounts owing by Buyer to Seller; and the acceptance by Seller of such check shall not constitute a waiver of Seller's right to pursue the collection of any remaining balance.
- b.) On any invoice not paid by maturity date (net thirty (30) days), Buyer shall pay interest from maturity to date of payment at the annual percentage rate of 18% (or such lower rate as may be the maximum allowable by law), together with Seller's costs of collection (including reasonable attorneys' fees).
- c.) Buyer agrees to pay the entire net amount of each invoice rendered by Seller pursuant to the terms of each such invoice without offset or deduction.
- d.) Prices for any undeliverable Products may be increased by Seller in the event of any increase in Seller's cost of supplies, raw materials, labor or services, or any increase in Seller's cost resulting from government action or other cause beyond Seller's control.

4. CREDIT:

Seller may in its sole discretion at any time and from time to time change the terms of Buyer's credit, require payment in cash before shipment of any or all of the Products specified herein, and/or require anticipated payment of any or all amounts due or to become due under this contract. If Seller believes in good faith that Buyer's ability to make payments called for by this contract is or may be impaired, Seller may cancel this contract or any remaining balance thereof, Buyer remaining liable to pay for any Products already shipped.

5. TAXES/FREIGHT:

Unless otherwise agreed in writing, the amount of all transportation charges from Seller's location and all taxes or other charges now or hereafter imposed by any government authority upon sale, purchase, resale, delivery, manufacture, production or possession of the Products specified herein, which may be paid by Seller or for which Seller may be liable, shall be paid to Seller by Buyer in addition to the purchase price of the Products.

6. ORDERS:

- a.) Each order for Products is subject to acceptance in writing by Seller.
- b.) Orders may not be cancelled or rescheduled after delivery by Seller to the carrier. In the event of allocation of Products, orders that are accepted by Seller will be accepted using a fair schedule method.
- c.) Special Orders - Special orders for items not normally stocked are non-cancelable and non-returnable.

7. DELIVERIES/TITLE:

- a.) All goods shall be packed in suitable containers for protection in shipment and storage. No special charges for packing or crating shall be made unless specifically listed as an additional and separate charge on Seller's quotation or acceptance of Buyer's order.
- b.) Subject to Seller's right of stoppage in transit, delivery of the Products to a carrier shall constitute delivery to Buyer, and risk of loss shall thereupon pass to Buyer; however, title shall remain in Seller until Buyer makes payment in full under contract. Products invoiced and held by Seller for any reason shall be at Buyer's risk and expense. Delivery route shall be the election of Seller unless specifically designated by Buyer.

- c.) Delivery of any installment of Products within 30 days after the date specified therefor shall constitute a timely delivery. Thereafter, delivery shall be deemed timely unless prior to shipment Seller has received written notice of cancellation. Delivery of a quantity which does not vary by more than 10% from the quantity specified therefor shall constitute full performance of such delivery. Delay in delivery of one installment shall entitle Buyer to cancel that installment only.
- d.) Should delivery of all or part of the Products specified herein (or any other obligation of Seller) be delayed by events beyond Seller's control, Seller's time for performance shall be extended by the period of delay, or Seller may, at its option, cancel this contract without liability, Buyer remaining liable for shipments already made. Sellers shall not be liable for any delays in or failures of delivery due to acts of God or public authority, labor disturbances, accidents, fires, floods, extreme weather conditions, failures of and delays by carriers, shortages of material, delays of a supplier due to causes beyond its control.
- e.) Buyer is deemed to have accepted the Products unless notice of rejection is given within a reasonable time, which is agreed to be within seven (7) days after receipt. Buyer waives any right to revoke acceptance thereafter.
- f.) No return of Products will be accepted by Seller without a return materials authorization number (RMA#), which will be issued in Seller's sole discretion. Returned Products must be in original shipping cartons, and must be freight prepaid. In the event any goods are proved to be other than as warranted, transportation costs to and from Seller's plant will be borne by Seller and reimbursement or credit will be made for amounts so expended by Buyer. Notice of defective Products must be made within seven (7) calendar days of receipt. A complete description regarding the nature of the defect must be included with all returned Products. All items not eligible for credit will be returned to Buyer, transportation collect.

8. SPECIFICATIONS AND DESIGNS:

- a.) Should Buyer request that changes be made in the specifications or design relating to any goods, delivery dates and schedules shall be revised accordingly, if necessary, and an equitable adjustment, upward or downward, shall be made in price in so far as warranted.
- b.) Any designs, tools, patterns, material, drawings, information or equipment furnished by Buyer, or any special tools made or acquired for the Buyer by the Seller which becomes Buyer's property, shall be used only in the production of the goods called for herein and not otherwise, unless by Buyer's written consent. Seller agrees to exercise reasonable care with respect to such property and equipment while in its possession and control, but shall not be responsible for loss or damage occurring without its fault or negligence or for ordinary wear and tear.

9. USE OF PRODUCTS:

- a.) If technical advice is offered or given in connection with the use of any Products it will be as an accommodation to Buyer and without charge and Seller shall have no responsibilities or liabilities whatsoever for the content or use of such advice.
- b.) Products sold by Seller are not designed for use in life support or nuclear applications. Seller's customers using or selling Products for use in life support or nuclear applications do so at their own risk, agree that Seller and the Manufacturer of Products are not liable, in whole or in part, for any claim or damage arising from such use, and agree to fully indemnify Seller and the Manufacturer from and against any and all damages, loss, cost, expense or liability arising out of or in connection with the use or performance of Products in life support or nuclear applications.
- c.) Should the Buyer notify the Seller that its order is placed under a prime contract with an agency of the United States Government, the following terms and conditions shall be incorporated into Seller's terms of sale in so far as the Buyer is required to incorporate such provisions in its purchase orders or subcontracts of terms in so far as applicable to the goods sold hereunder.
- d.) The following clause set forth or referred to in Sections 7 and 12 of the Armed Services Procurement Regulations are hereby incorporated by reference: Renegotiation Act (7-103.17 12-604), Nondiscrimination in Employment (7-103.18 12-802), Officials Not to Benefit (7-103.19), Buy American Act (7-104.3 6-104.5), Notice to the Government of Labor Disputes (7-104.4), Excess Profit (7-104.11), Military Security Requirements (7-104.12), Examination of Records (7-104.15), Convict Labor (7-104.17 12-203). In order to make the context of the above clauses applicable to these terms of sale, the word "Buyer" shall be substituted for the word "Government" and the word "Seller" shall be substituted for the word "contractor" whenever necessary.
- e.) Unless the design for the goods shall have been furnished by the Buyer to the Seller and used by the Seller in manufacturing the goods, Seller shall defend and save harmless the Buyer from any claim that any product or article sold to the Buyer hereunder in and of itself infringes any United States letters patent by reason of its sale or use/ provided Seller is notified in writing within ten (10) days after any such claim is made against the Buyer, and provided further that Seller is permitted to defend the same in Buyer's name if action be brought. If the product or article sold to the Buyer hereunder is manufactured by the Seller according to a design furnished by the Buyer, the Buyer will defend and save harmless the Seller from any claims of infringement of any United States Letters patent.

10. TOOLING:

Tool, die, and pattern charges, if any, are in addition to the price of the Goods and are due and payable upon completion of the tooling. All such tools, dies and patterns shall be and remain the property of Seller. Charges for tools, dies, and patterns do not convey to Buyer, title, ownership interest in, or rights to possession or removal, or prevent their use by Seller for other purchasers, except as otherwise expressly provided by Seller and Buyer in writing with reference to this provision.

11. INSTALLATION/TRAINING:

Buyer acknowledges that no installation, training or education is contracted for or purchased under terms of this contract unless specifically agreed in writing. In the event that Buyer receives any training from Seller with respect to the Products, then, in that event, such training is personal to the persons receiving such training, and Buyer acknowledges that any persons receiving such training may not be capable of operating the Products.

12. RESTOCKING POLICY:

Merchandise that is returned must be accompanied by pre-approved return materials authorization number (RMA#). Return authorizations will be approved by Canfield Connector. When materials are received, an inspection will be performed to determine if restocking charges are applicable. Material that does not have an authorization will be returned to the purchaser at their expense. RETURNED ITEMS MAY ENTAIL A RESTOCKING CHARGE. CONSULT FACTORY FOR EXACT RESTOCKING FEES. AS CHARGES MAY VARY DEPENDING ON THE AMOUNT OF SPECIALTY OF THE ITEMS BEING RETURNED. CUSTOM PARTS & "9-" NUMBERS ARE NON-RETURNABLE AND NON-REFUNDABLE (EXCEPT IN CASES OF WARRANTY)

Table of Contents

Introductory Information

- 5 Sensor / Groove Cross Reference Chart
- 6 Reed or Electronic
- 7 Proximity Sensor Types











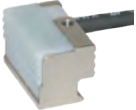
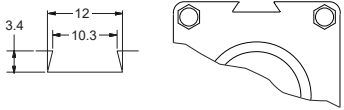

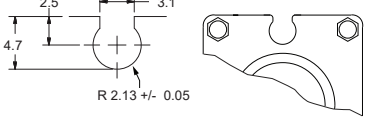

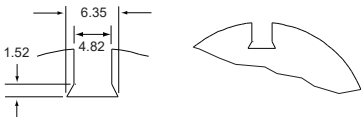

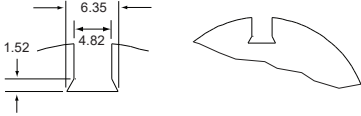

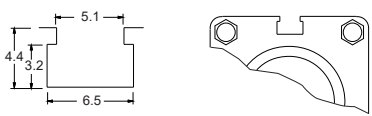
Cylinder Proximity and Inclinator Sensors

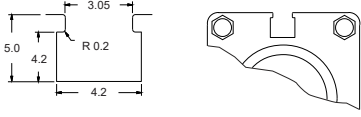
- 8 7000 - Reed & Electronic Sensors for Tie-rod and Round Cylinders
- 10 7C - Reed & Electronic Sensors for Tie-rod Cylinders
- 12 7GL - General Location Sensors for Tie-rod Cylinders
- 13 7HL - Hazardous Location Sensors for Tie-rod Cylinders
- 14 8000 - Reed & Electronic Sensors for Tie-rod, Round or Extruded Cylinders
- 16 8WS - Reed & Electronic Sensors for 12mm Dovetail Applications
- 18 9C - Reed & Electronic Sensors for Round Keyway Applications
- 20 9D - Reed & Electronic Sensors for Universal Applications
- 22 9E - Reed & Electronic Sensors for Universal Applications
- 24 9F - Reed & Electronic Sensors for 4mm "T" Slot Applications
- 26 9H - Reed & Electronic Sensors for 4.2mm "T" Slot Application
- 28 9K - Reed & Electronic Sensors for 4.2mm "U" Slot Applications
- 30 9M50 - Reed & Electronic Sensors for 6.5mm Groove Applications
- 32 9Q - Reed & Electronic Sensors for Universal "T" Slot Applications
- 34 9U - Reed & Electronic Sensors for Universal Applications
- 36 CS - All Threaded Sensors for Universal Applications
- 38 EiS - Electronic Inclinator Sensor
- 40 EiS J1939 and CANopen - Electronic Inclinator Sensor
- 42 ETS - Electronic Tilt Switch

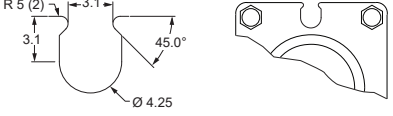
Additional Information

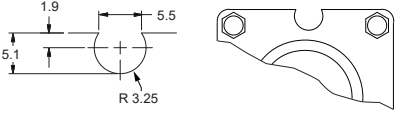
- 44 Glossary of Terms

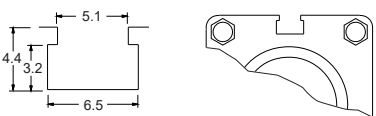
Sensor / Groove Cross Reference Chart

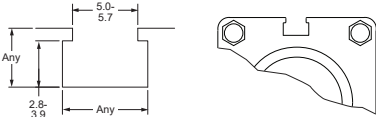
8WS Dovetail			Numatics
9C Round Keyway			DE-STA-CO Robohand SMC Bimba Compact Air Fabco
9D Universal Dovetail			Fabco Numatics Rotomation
9E Universal Dovetail			Fabco Numatics Rotomation
9F 4mm T-Slot			Fabco Festo Numatics Rotomation
9H 4.2mm T-Slot			4x4 Groove
9K 4.2mm U Groove			Mindman Koganei
9M50 6.5mm D Groove			Norgren
9Q Universal T-Slot			Parker Fabco Festo Numatics Rotomation
9U Universal T-Slot			Fabco Festo Numatics Parker SMC

NOTE: All trademarks used in this catalog are the property of their respective owners.

REED OR ELECTRONIC? Which type of sensor should I use

The type of sensor that is best for a particular application depends on the operating parameters and cost related issues. Canfield Connector is proud to offer the industry's best value in Reed and Electronic Sensors. However if our sensors are misapplied, they could fail prematurely. Therefore, give careful consideration when selecting the proper proximity sensor for your application. We have prepared this catalog with all the necessary information in order to aid in this decision. If you require more assistance or have any questions, please feel free to call. Our customer service and engineering staff will be happy to assist you. *For technical assistance, please call - (330) 758-8299 or visit our web site at www.canfieldconnector.com*

Reed Switch Sensors:

If initial cost and versatility are most important, then reed switch sensors should be considered. For example the 7000 Series Type 04 reed switch will operate from 5 to 240 volts AC or DC. Generally, one switch can be stocked to cover a large majority of common applications. Please note, reed sensors do not work well with inrush surge currents and transients (common to inductive & capacitive loads; i.e. relays, coils & long wire runs). If inrush surge currents and transients must be accommodated, switch Types 21 - 29 may be specified. These parameters should be given careful consideration when selecting a proximity device that will be best suited for an application.

Electronic Sensors:

In general, if longevity is a major concern, electronic sensors should be used whenever they fit within the operating parameters specified for a given application. They should receive special attention when high cycle rates are required. If electronic sensors are used within their operating range they will always outperform and outlast mechanical reed sensors. The initial added cost associated with a electronic sensor will be outweighed should the application require high cycle rates.

PRINCIPLES OF OPERATION FOR MAGNETIC PROXIMITY SWITCHES

Reed / Electronic Switch Working Principle

Our reed switch sensors contain hermetically sealed reed elements (mechanical contacts) which can be open or closed in their normal state depending on the version selected. When a magnetic field moves within proximity of the switch, magnetism is induced into the leads and forces the contacts to change state (open if normally closed or closed if normally open). Typically used with air cylinders that are built with internal magnetic pistons.

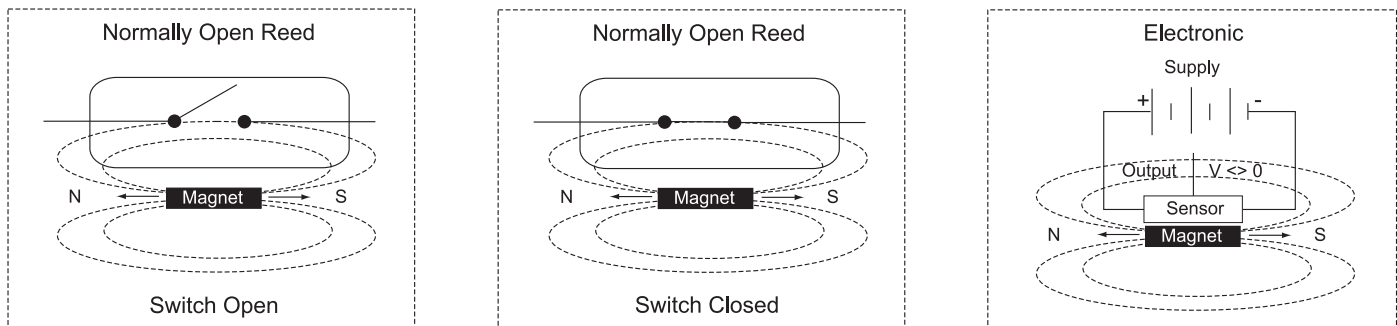

Note: Arrows indicate movement of magnet in relation to switch surface.

Sinking (NPN) vs. Sourcing (PNP)

Electronic switches are available in Sinking or Sourcing versions. The basic difference between these two ways of solid state switching is as follows:

The Sourcing method connects or switches one side of the load to the positive (+) side of the supply. The negative (-) side is connected directly to the other side of the load as shown in figure 1. PNP is the acronym used to describe the transistor that performs this type of switching in a solid state sensor.

The Sinking method connects or switches one side of the load to the negative (-) side of the supply. The positive (+) side is connected directly to the other side of the load as shown in figure 2. NPN is the acronym used to describe the transistor that performs this type of switching in a solid state sensor.

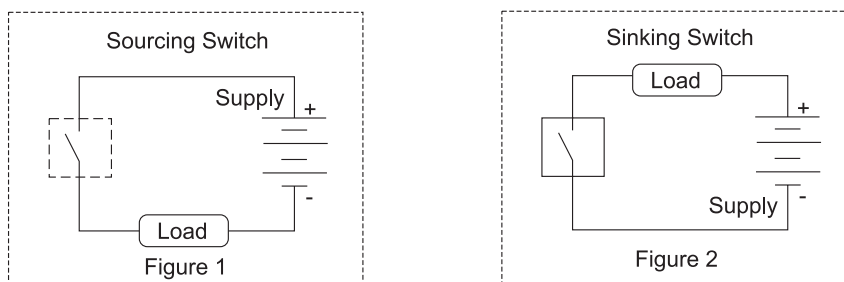

PROXIMITY SENSOR TYPES

Reed Switch Sensors:

Type 01 & 05 -

These two sensors are the most basic types. They are made up of a reed element only. The Type 01 is single pole, single throw, normally open and the Type 05 is single pole, single throw, normally closed. These sensors act as an in line switch which is actuated in a magnetic field, with no minimum current requirement.

- Features:
- Lowest cost
 - Non polarity dependent
 - CSA versions available
 - AC or DC operation
 - Zero leakage current
 - High power capacity
 - Nema 6 versions available

Type 02 and 04 & 09 -

The Type 02 is current limiting and is single pole, single throw, normally open. The Type 04 is single pole, single throw, normally open and Type 09 is single pole, single throw, normally closed. They act as an in line switch which is actuated in a magnetic field. These sensors also include an LED indicator and surge suppression. Surge suppression helps to extend the life of the sensor when it is used to switch higher current loads and / or inductive loads. The Type 04 & 09 are similar to the Type 01 & 05, in that they perform the same function.

- Features:
- Lowest cost
 - Polarity protection
 - CSA versions available
 - AC or DC operation
 - Zero leakage current
 - LED indicator
 - High power capacity
 - Nema 6 versions available

Type 06 -

This sensor is a reed type sensor which uses a single pole, double throw element. This enables the switching of two separate loads. One side of the switch is normally closed and the other is normally open. This sensor also included an LED indicator which is connected to the normally open side of the switch. The LED indicator operates when the normally open side is closed with a minimum 5mA current flowing through the switch and a typical 3 volt drop.

- Features:
- AC or DC operation
 - High power capacity
 - Zero leakage current
 - CSA versions available
 - LED indicator on normally open
 - Nema 6 versions available

Type 21 & 25 and 23, 24 & 29 -

These sensors are designed specifically to switch high power AC loads (including inductive loads) and loads with high transient or inrush currents, although they are not limited to these applications. These sensor types all use a reed element to sense a magnetic field and a triac to drive the output, and include standard surge suppression. This configuration provides excellent longevity even under the most demanding conditions. The Type 21 & 25 utilize a two wired switch has no LED and Types 23, 24 & 29 utilize a three wired switch with LED.

- Features:
- Solid state triac output = long life
 - High power capacity
 - CSA versions available
 - Low voltage drop
 - Resistant to current inrush
 - Zero leakage current
 - Nema 6 versions available

Electronic Sensors:

Type 15 & 16 -

These two sensors use magnetoresistive elements with no magnetic polarity. They are 100% solid state, and have no moving parts, resulting in extremely long life expectancy. These virtually vibration and shock proof sensors utilize a rugged triac to switch power convenient AC voltage (common to reed switches) combined with the reliability of solid state technology (common to electronic switches).

- Features:
- Solid state circuitry = long life
 - LED indicator
 - Resistant to current inrush
 - Low voltage drop
 - CSA versions available
 - Nema 6 versions available
 - AC operation
 - Resistant to shock and vibration
 - No minimum current to operate

Type 31 & 32 -

These sensors use magnetoresistive elements with no magnetic polarity. They are 100% solid state, and have no moving parts, resulting in extremely long life expectancy. They are designed to operate within 6 to 24V DC, and are available in two configurations: NPN (Sinking) output and PNP (Sourcing) output. Both include an indicator light which illuminates when the switch is actuated. No minimum load current and low voltage drop make them ideal for use with programmable controllers.

- Features:
- Solid state circuitry = long life
 - LED indicator
 - Resistant to current inrush
 - Low voltage drop
 - CSA versions available
 - Nema 6 versions available
 - No minimum current to operate
 - High power capacity
 - Highly shock and vibration resistant



**canfield
connector**

7000 SERIES

REED AND ELECTRONIC SENSORS FOR
2" TO 8" BORE TIE ROD CYLINDERS
OR 3/4" TO 4" ROUND CYLINDERS

GENERAL DESCRIPTION

The Canfield 7000 Series proximity sensors are used to sense position on cylinders. They accommodate 2 to 8 inch bore tie rod cylinders or 3/4 to 4 inch round cylinders. This proven design is rugged yet cost effective. The Series 7000 boasts the largest number of custom circuits to match applications found in the market. Examples include; 1 or 4 Amp reed switches, normally open, normally closed or SPDT switch types, reed or electronic sensing elements in the same package style, and the industry's first 120 VAC Hall sensor. A wide range of enclosures and connector options are available. To reduce stocking requirements, two clamp options feature a self-adjusting clamp for NFPA and other tie rod cylinders from 2 to 8 inch bore. Another clamp option features a band clamp from 3/4 to 4 inch round cylinders.



DIMENSIONAL DATA

All dimensions are in millimeters unless otherwise noted.

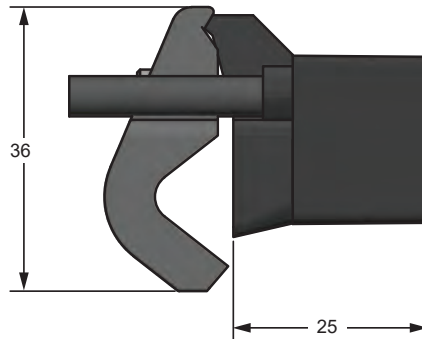

CONNECTION OPTION

12mm

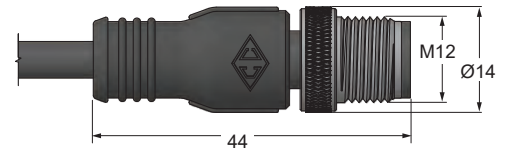

MOUNTING / CLAMP STYLES

STYLE: 0

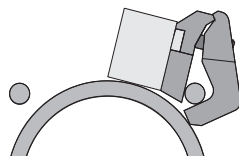

Clamp for NFPA
tie-rod cylinders
Universal 2" to 6" bore.

STYLE: 9

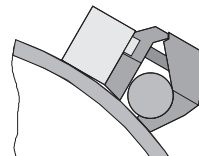

Clamp for NFPA
tie-rod cylinders
6" to 8" bore.



**canfield
connector**

7C SERIES
REED AND ELECTRONIC SENSORS
FOR 2" TO 8" BORE
TIE ROD CYLINDERS

GENERAL DESCRIPTION

The Canfield Connector 7C Series proximity sensors are used to sense position on pneumatic actuators equipped with magnetic pistons from 2" to 8" bore. This proven design is rugged yet cost effective. All switches feature a self-adjusting clamp that grips standard NFPA and custom cylinders eliminating stocking requirements of many clamps for different bore sizes. The Series 7C boasts the largest number of custom circuits to match applications found in the market. Examples include; 1 or 4 Amp reed switches, normally open, normally closed or SPDT switch types, reed or electronic sensing elements in the same package style, not to mention the industry's first 120 VAC Hall sensor. The low cost 7C features a 1/2" conduit hub and wire lead to meet stringent electrical codes in certain regions and applications.



DIMENSIONAL DATA

All dimensions are in millimeters unless otherwise noted.

1/2" CONDUIT

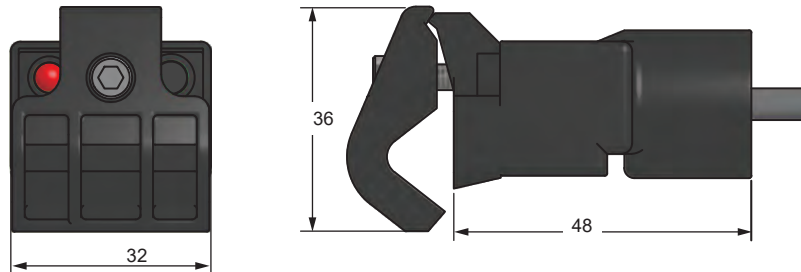

3 / 5 PIN AUTOMOTIVE

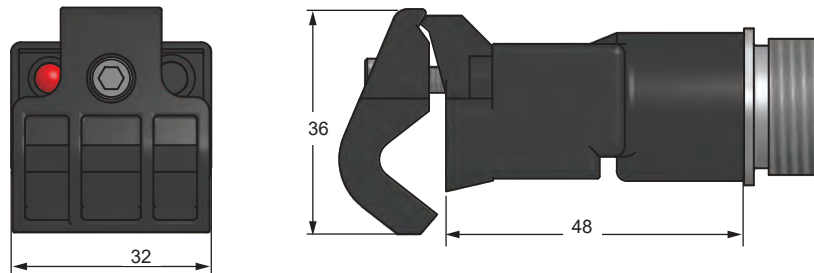

MOUNTING / CLAMP STYLES

STYLE: 0

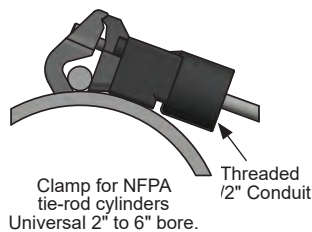

STYLE: 9

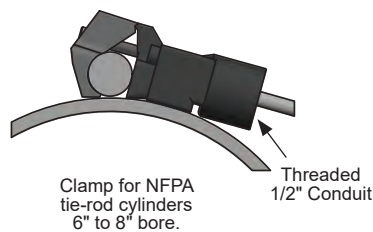

TECHNICAL DATA

Switch Type / Tech. Specs.	See Ordering Information†
Sensitivity / Orientation	Reed / Electronic: 85 Gauss Parallel (measured from sensor surface)
Shock	Up to 30G (11ms) Reed Only (not applicable for electronics)
Vibration	Up to 20G (10-55 Hz) Reed only
Materials	Cable: PVC House: PEI, PA
Temperature Range	-20° to +80°C
Environmental Protection	Designed for IP 67 / NEMA 6
Cable Diameter	5.1mm
Wire Gauge	22 AWG standard

PIN CONFIGURATION

Automotive Connector

STYLE: 3
3 Pin



STYLE: 4
5 Pin

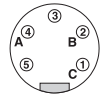

ORDERING INFORMATION

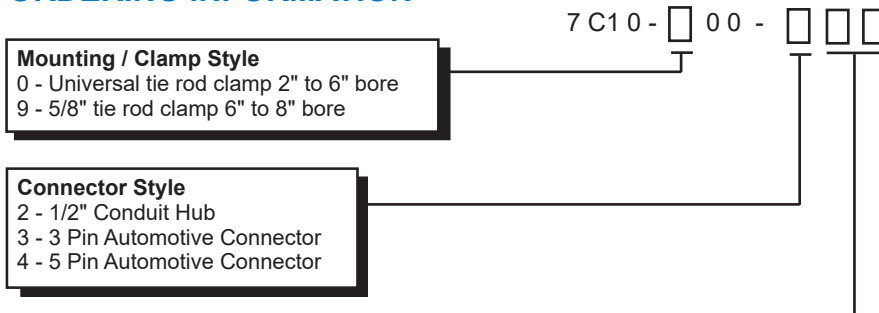

Switch† Type	Description	Function	Switching Voltage	Switching Current	Switching Power	Voltage Drop
01	Reed Switch, 2 Wire	Normally Open SPST	0 - 240V AC/DC 50/60 Hz	1 Amp max.	30 Watts max.	0 Volts
04	Reed Switch, MOV, Red LED, 2 Wire	Normally Open SPST	5 - 240V AC/DC 50/60 Hz	1 Amp max. .005 Amps min.	30 Watts max.	3 Volts
05	Reed Switch, 2 Wire	Normally Closed SPST	0 - 120V AC/DC 50/60 Hz	1 Amp max.	20 Watts max.	0 Volts
06	Reed Switch, Red LED, 3 Wire	Single Pole, Double Throw	5 - 120V AC/DC 50/60 Hz	1 Amp max. .005 Amps min.	20 Watts max.	3Volts/load1 0Volts/load2
09	Reed Switch, MOV, Red LED, 2 Wire	Normally Closed SPST	5 - 120V AC/DC 50/60 Hz	1 Amp max. .005 Amps min.	20 Watts max.	3 Volts
15	AC Electronic Sensor for Reed Magnets, Red LED, 3 Wire	Normally Open TRIAC output	12-24 VAC	600 mA max. 5 Amps Inrush	15 Watts max.	1 Volt
16	AC Electronic Sensor for Reed Magnets, Red LED, 3 Wire	Normally Open TRIAC output	120 VAC	600 mA max. 5 Amps Inrush	72 Watts max.	1 Volt
21	Reed Switch, MOV, 2 Wire	Normally Open TRIAC output	10 - 240 VAC 50/60 Hz	4 Amps max. 50 Amps Inrush	100 Watts max.	1 Volt
23	Reed Switch, MOV, Red LED, 3 Wire	Normally Open TRIAC output	10 - 50 VAC 50/60 Hz	4 Amps max. 50 Amps Inrush .005 Amps min.	100 Watts max.	1 Volt
24	Reed Switch, MOV, Red LED, 3 Wire	Normally Open TRIAC output	24 - 240 VAC 50/60 Hz	4 Amps max. 50 Amps Inrush .005 Amps min.	100 Watts max.	1 Volt
25	Reed Switch, MOV, 2 Wire	Normally Closed TRIAC output	10-120 VAC 50/60 Hz	4 Amps max. 50 Amps Inrush	100 Watts max.	1 Volt
29	Reed Switch, MOV, Red LED, 3 Wire	Normally Closed TRIAC Output	10-120 VAC 50/60 Hz	4 Amps max. 50 Amps Inrush .005 Amps min.	100 Watts max.	1 Volts
31	Electronic for Reed Magnet, Red LED & Sourcing, 3 Wire	Normally Open PNP	6 - 24 VDC	1 Amp max.	24 Watts max.	0.5 Volts
32	Electronic for Reed Magnet, Red LED & Sinking, 3 Wire	Normally Open NPN	6 - 24 VDC	1 Amp max.	24 Watts max.	0.5 Volts

Ordering Example: 7C10-000-204

Universal tie rod clamp, 1/2" conduit hub,
reed switch, lighted, MOV surge suppression,
normally open, 5 - 240V AC/DC 50/60 Hz



**canfield
connector**

7GL SERIES
GENERAL LOCATION MAGNETIC
PROXIMITY SENSORS
FOR TIE ROD CYLINDERS

GENERAL DESCRIPTION

The Canfield Connector 7GL is an expansion of the popular Series 7000 “floating” clamp design, which adapts to NFPA tie rod linear actuators with 2 to 8 inch bore. This rugged magnetic proximity sensor can sense actuator position in stringent, general location applications. The switch features a robust, aircraft aluminum body, epoxy-filled, vibration and shock resistant, electronic circuit. Available in a normally open contact, the 7GL can switch current up to .5 Amps and has a voltage range of 0-120VAC/VDC 50/60 Hz.



DIMENSIONAL DATA

All dimensions are in millimeters unless otherwise noted.

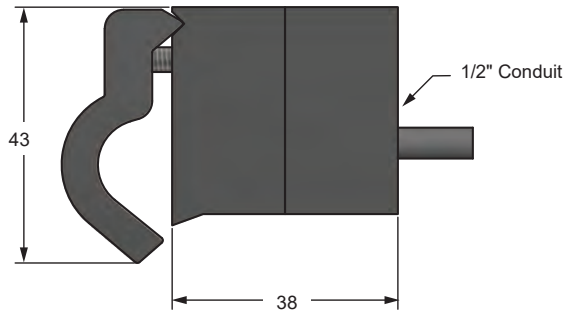
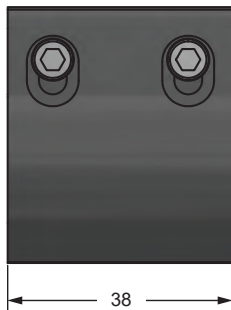

TECHNICAL DATA

Switch Type	S.P.S.T., Normally Open, Reed
Operating Voltage	0-120 V AC/DC 50/60 Hz
Load Max.	10W, Resistive only
Current Max.	0.5A
Response Time	On: 0.5ms Off: 0.1ms
Sensitivity / Orientation	85 Gauss Parallel (measured from sensor surface)
Shock	Up to 30G (11mS)
Vibration	Up to 20G (10-55 Hz)
Materials	Cable: PVC House: Anodized 6061-T6 Aluminum, Epoxy encapsulated printed circuit board
Temperature Range	-20° to +80°C
Environmental Protection	Designed for NEMA 1, 4 and 13
Cable Diameter	.19mm
Wire Gauge	20 AWG standard
Wire Length	9 Ft. standard

MOUNTING INSTALLATION

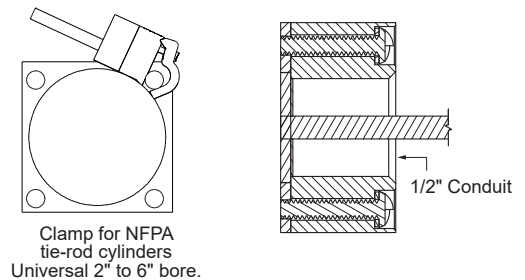

ELECTRICAL INSTALLATION

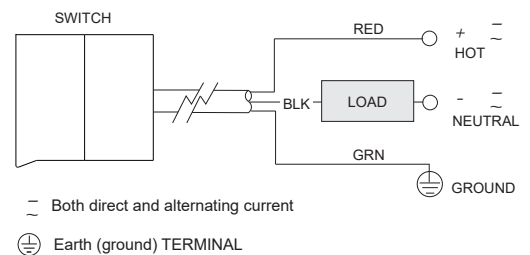

ORDERING INFORMATION

7GL10-000-001

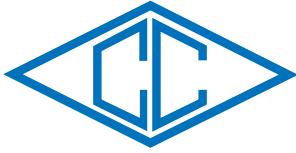

**canfield
connector**

7HL SERIES
HAZARDOUS LOCATION MAGNETIC
PROXIMITY SENSORS
FOR TIE ROD CYLINDERS

GENERAL DESCRIPTION

The Canfield Connector 7HL is a rugged magnetic proximity sensor designed to sense actuator position in stringent, hazardous location applications. The switch features a robust, epoxy-filled, aircraft aluminum body, and has a vibration and shock resistant, electronic circuit. The 7HL is an expansion of the popular Series 7000 "floating" clamp design and will clamp on 2 to 8 inch bore NFPA tie rod linear actuators. This product is designed to operate in hazardous locations, this switch is CSA approved for Class I, Division 2, Groups A, B, C, and D; Class II, Division 2, Groups F and G; and Class III.



DIMENSIONAL DATA

All dimensions are in millimeters unless otherwise noted.

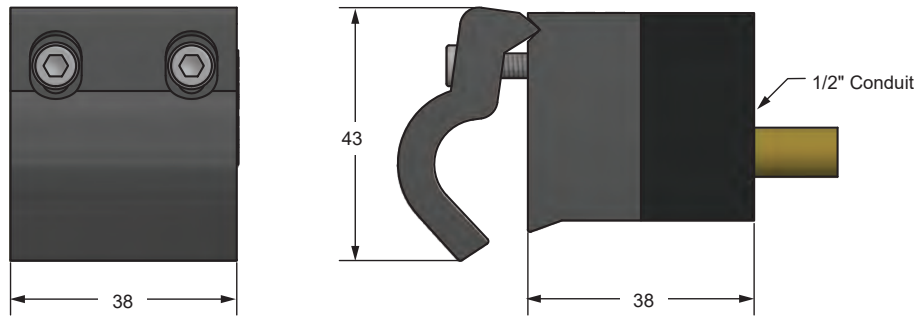

TECHNICAL DATA

Switch Type	S.P.S.T., Normally Open, Reed
Operating Voltage	0-120 V AC/DC 50/60 Hz
Load Max.	10W, Resistive only
Current Max.	0.5A
Response Time	On: 0.5ms Off: 0.1ms
Sensitivity / Orientation	85 Gauss Parallel (measured from sensor surface)
Shock	Up to 30G (11mS)
Vibration	Up to 20G (10-55 Hz)
Materials	Cable: PVC House: Anodized 6061-T6 Aluminum, Epoxy encapsulated printed circuit board
Temperature	Code: T6 Range: -20° to +80°C
Environmental Protection	Designed for NEMA 1, 4 and 13
Hazardous Location Rating	CSA: Class I, Division 2, Groups A, B, C and D; Class II, Division 2, Groups F and G; and Class III
Cable Diameter	.310mm
Wire Gauge	SJTOW type, 18 AWG standard
Wire Length	9 Ft. standard

MOUNTING INSTALLATION

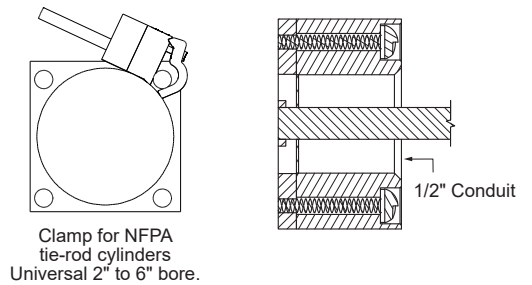

ELECTRICAL INSTALLATION

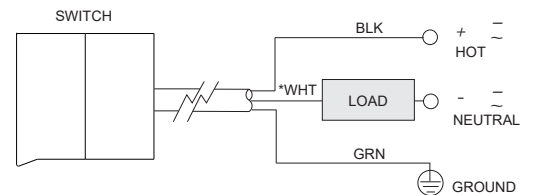

~ Both direct and alternating current

⊕ Earth (ground) TERMINAL

*White wire must be permanently reidentified to indicate its use as an ungrounded conductor, by painting or other effective means at its termination, and each location where the conductor is visible and accessible. Per NEC Article (200.7)

ORDERING INFORMATION

7HL10-000-001

Consult factory for available versions listed by Canadian Standards Association for use with certified electrical equipment.

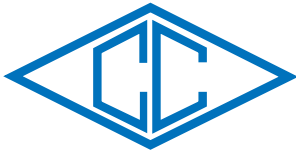

**canfield
connector**

8000 SERIES
REED & ELECTRONIC SENSORS
FOR ROUND, TIE-ROD, OR
EXTRUDED CYLINDERS

GENERAL DESCRIPTION

The Canfield Connector 8000 Series Reed and Electronic sensors are compact units designed for sensing applications on round cylinders from 9/16" - 4" and tie-rod pneumatic cylinders from 3/4" - 8" bore. These sensors offer a wide voltage range from 0-120 VAC/VDC 50/60 Hz and high current capacity up to 0.5 Amps. They include high intensity indicator lights and a wide viewing angle. The sensor's small package can fit easily on the smallest cylinder without appearing too large. The Series 8000's design promotes ease of installation with a tight fit. Options include 9ft. PVC or 8mm quick connect male pigtail.



DIMENSIONAL DATA

All dimensions are in millimeters unless otherwise noted.

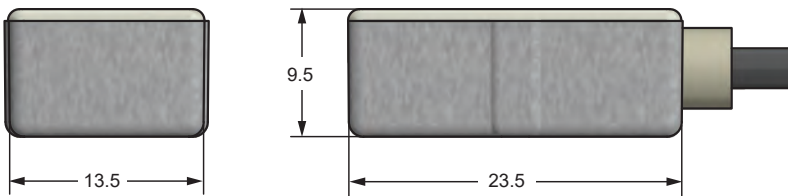

CONNECTION OPTION

8mm

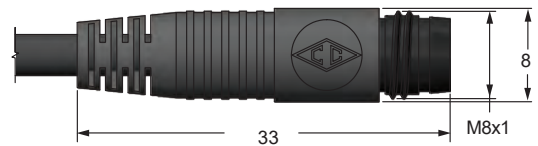

MOUNTING / CLAMP STYLES

STYLE: 0

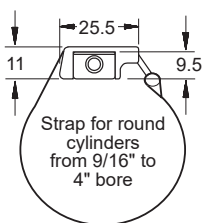

STYLE: 2

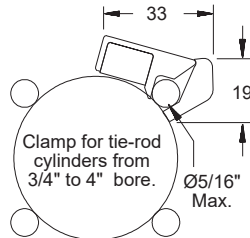

STYLE: 3

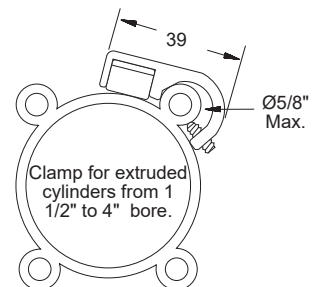

STYLE: 5-9

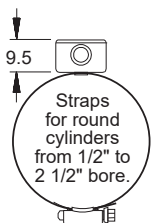

STYLE: A

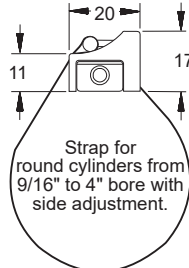

STYLE: B

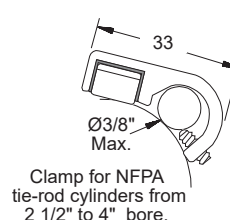

STYLE: C

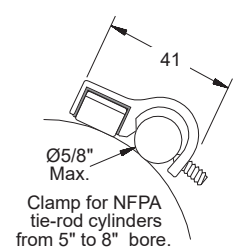

TECHNICAL DATA

Switch Type / Tech. Specs.	See Ordering Information [†]
Sensitivity / Orientation	Reed / Electronic: 85 Gauss Parallel (measured from sensor surface)
Shock	Up to 30G (11mS) Reed Only (not applicable for electronics)
Vibration	Up to 20G (10-55 Hz) Reed only
Materials	Cable: PVC House: PA
Temperature Range	-20° to +80°C
Environmental Protection	Designed for IP 65 / NEMA 4, IP 67 / NEMA 6 available on request
Cable Diameter	3.7mm
Wire Gauge	24 AWG standard

(ADDITIONAL) MATING CORDSETS / PIN CONFIGURATION

8mm female molded locking connector

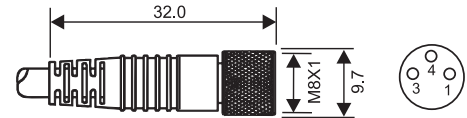

Brown = Pin 1
Blue = Pin 3
Black = Pin 4

Order P/N:

RC08-AFM030-0120C10A (2m length)
RC08-AFM030-0150C10A (5m length)

ORDERING INFORMATION

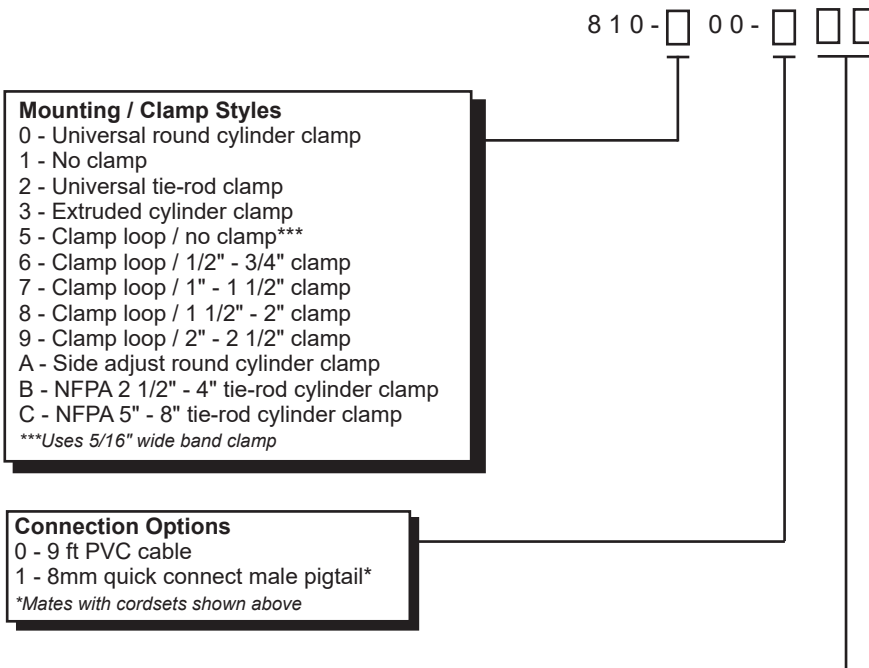

Mounting / Clamp Styles

- 0 - Universal round cylinder clamp
 - 1 - No clamp
 - 2 - Universal tie-rod clamp
 - 3 - Extruded cylinder clamp
 - 5 - Clamp loop / no clamp***
 - 6 - Clamp loop / 1/2" - 3/4" clamp
 - 7 - Clamp loop / 1" - 1 1/2" clamp
 - 8 - Clamp loop / 1 1/2" - 2" clamp
 - 9 - Clamp loop / 2" - 2 1/2" clamp
 - A - Side adjust round cylinder clamp
 - B - NFPA 2 1/2" - 4" tie-rod cylinder clamp
 - C - NFPA 5" - 8" tie-rod cylinder clamp
- ***Uses 5/16" wide band clamp

Connection Options

- 0 - 9 ft PVC cable
 - 1 - 8mm quick connect male pigtail*
- *Mates with cordsets shown above

Switch [†] Type	Description	Function	Switching Voltage	Switching Current	Switching Power	Voltage Drop	Magnetic Sensitivity
01	Reed Switch	Normally Open SPST	0 - 120V AC/DC	0.5 Amps Max.	10 watts Max.	0 Volts	85 Ga.
02	Reed Switch & Red LED	Normally Open SPST	5 - 120V AC/DC	0.025 Amps Max. 0.001 Amps Min.	3 watts Max.	6.0 Volts	85 Ga.
04	Reed Switch, Red LED & MOV	Normally Open SPST	5 - 120V AC/DC	0.5 Amps Max. 0.005 Amps Min.	10 watts Max.	3.0 Volts	85 Ga.
31	Electronic for Reed Magnet, Red LED & Sourcing	Normally Open PNP	6 - 24 VDC	0.3 Amps Max.	7.2 watts Max.	.5 Volts	85 Ga.
32	Electronic for Reed Magnet, Red LED & Sinking	Normally Open NPN	6 - 24 VDC	0.3 Amps Max.	7.2 watts Max.	.5 Volts	85 Ga.

 Consult factory for available versions listed by Canadian Standards Association for use with certified electrical equipment.

Ordering Example: 810-000-002

Universal round cylinder clamp, 9ft PVC cable, reed switch with LED, SPST, normally open, 5 - 120V AC/DC



**canfield
connector**

8WS SERIES

REED & ELECTRONIC SENSORS
FOR PNEUMATIC CYLINDERS
FOR 12MM DOVETAIL GROOVE

GENERAL DESCRIPTION

The Canfield Connector 8WS Series reed and electronic magnet sensors are rugged yet compact switches used to sense position on pneumatic actuators equipped with a magnetic piston and 12mm dovetail groove. The switch can be slipped in and tightened from anywhere along the groove that is fabricated into the cylinder wall or clamping system. The switch features a die cast holder which clamps to the cylinder groove while the electronics are fully encapsulated and resistance to environment. These sensors offer a wide voltage range from 0-120 V AC/DC 50/60Hz and have a up to a 500 mA switching current rating. The switch has a high intensity indicator light which indicates power to the switch and load. Options include 9ft. PVC or 8mm quick connect male pigtail.



DIMENSIONAL DATA

All dimensions are in millimeters unless otherwise noted.

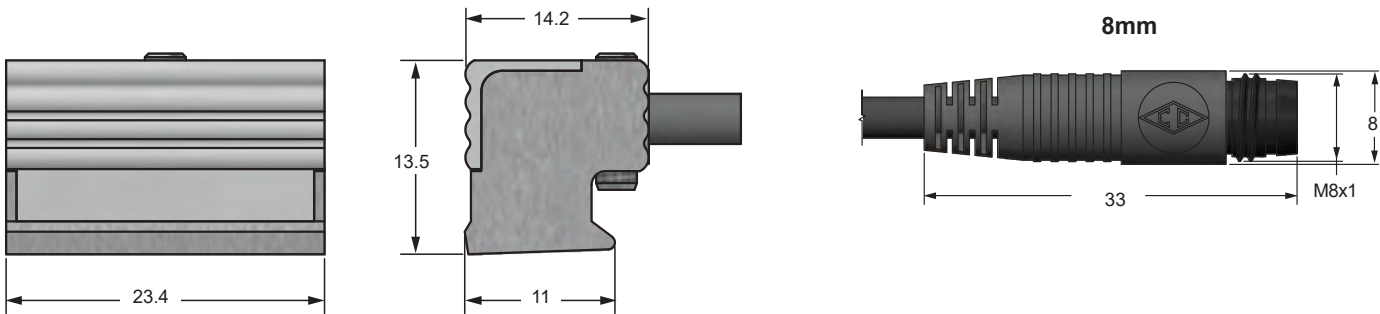

GROOVE DETAILS

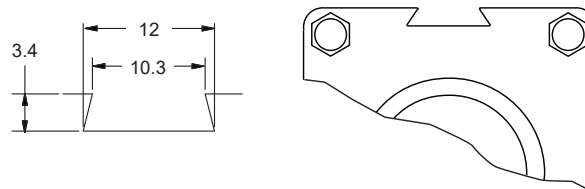

(Fits: Numatics)

TECHNICAL DATA

Switch Type / Tech. Specs.	See Ordering Information†
Sensitivity / Orientation	Reed / Electronic: 85 Gauss Parallel (measured from sensor surface)
Shock	Up to 30G (11mS) Reed Only (not applicable for electronics)
Vibration	Up to 20G (10-55 Hz) Reed only
Materials	Cable: PVC House: PA
Temperature Range	-20° to +80°C
Environmental Protection	Designed for IP 67 / NEMA 6
Cable Diameter	3.7mm
Wire Gauge	24 AWG standard

(ADDITIONAL) MATING CORDSETS / PIN CONFIGURATION

8mm female molded locking connector

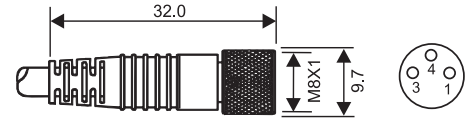

Brown = Pin 1
Blue = Pin 3
Black = Pin 4

Order P/N:

RC08-AFM030-0120C10A (2m length)
RC08-AFM030-0150C10A (5m length)

ORDERING INFORMATION

8WS10-000-□□□

Connection Options

0 - 9 ft PVC cable
1 - 8mm quick connect male pigtail*
**Mates with cordsets shown above*

Switch Type†	Description	Function	Switching Voltage	Switching Current	Switching Power	Voltage Drop	** Magnetic Sensitivity
01	Reed Switch	Normally Open SPST	0 - 120V AC/DC	0.5 Amps Max.	10 watts Max.	0 Volts	85 Ga.
02	Reed Switch & Red LED	Normally Open SPST	5 - 120V AC/DC	0.025 Amps Max. 0.001 Amps Min.	3 watts Max.	6.0 Volts	85 Ga.
04	Reed Switch, Red LED & MOV	Normally Open SPST	5 - 120V AC/DC	0.5 Amps Max. 0.005 Amps Min.	10 watts Max.	3.0 Volts	85 Ga.
31	Electronic for Reed Magnet, Red LED & Sourcing	Normally Open PNP	6 - 24 VDC	0.3 Amps Max.	7.2 watts Max.	.5 Volts	85 Ga.
32	Electronic for Reed Magnet, Red LED & Sinking	Normally Open NPN	6 - 24 VDC	0.3 Amps Max.	7.2 watts Max.	.5 Volts	85 Ga.

**Minimum gauss rating required for proper operation. Size of sensing area depends upon size and strength of magnet and thickness of cylinder wall.



Consult factory for available versions listed by Canadian Standards Association for use with certified electrical equipment.

Ordering Example: 8WS10-000-002

9 ft. PVC cable, reed switch with LED, SPST normally open, 5 - 120V AC/DC

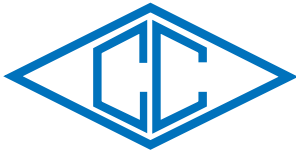

canfield
connector

9C SERIES
REED & ELECTRONIC
MAGNETIC SENSORS FOR
ROUND KEYWAY GROOVE

GENERAL DESCRIPTION

The 9C Series is a compact, universal, magnetically operated proximity switch commonly used on aluminum extruded profile type linear actuators equipped with magnetic pistons. The switches are available in both reed and electronic styles and made to fit into a 4mm key hole type slot. Position fixing is accomplished by means of a screw that is supplied in the switch body. The on board indicator light shows instant switch diagnostics to minimize downtime and facilitate installation and can be seen from wide angles. Available in the standard 9 ft. PVC wired or optional 8mm quick connect, the switch can handle AC or DC current in several configurations. The 9C is constructed of engineered polymers and designed to meet IP 67 / NEMA 6 environmental specifications.



DIMENSIONAL DATA

All dimensions are in millimeters unless otherwise noted.

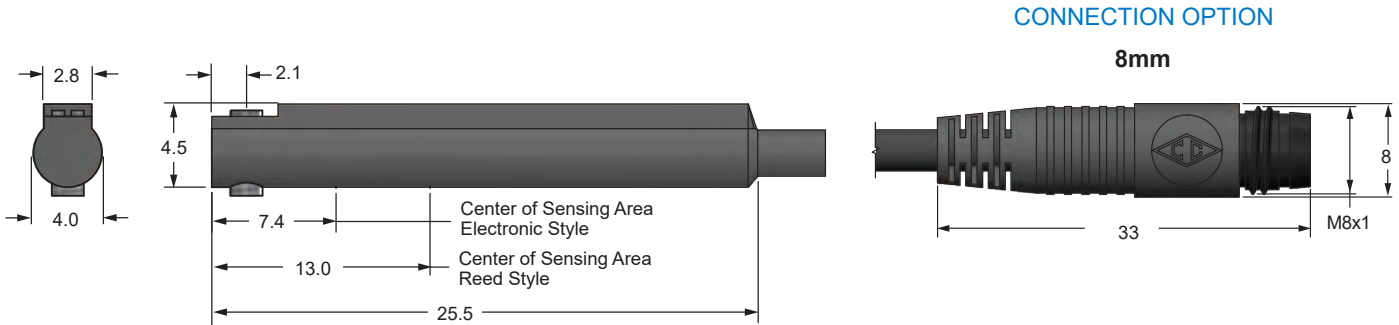

GROOVE DETAILS

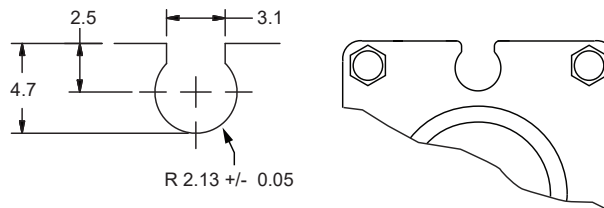

(Fits: DE-STA-CO, Robohand, SMC, Bimba, Compact Air, Fabco)

TECHNICAL DATA

Switch Type / Tech. Specs.	See Ordering Information†
Sensitivity / Orientation	Electronic: 40 Gauss Parallel Reed: 85 Gauss Parallel (measured from sensor surface)
Shock	Up to 30G (11mS) Reed Only (not applicable for electronics)
Vibration	Up to 20G (10-55 Hz) Reed only
Materials	Cable: PVC House: PBT, TPU
Temperature Range	-10° to +70°C
Environmental Protection	Designed for IP 67 / NEMA 6
Cable Diameter	2.7mm
Wire Gauge	26 AWG standard

(ADDITIONAL) MATING CORDSETS / PIN CONFIGURATION

8mm female molded locking connector

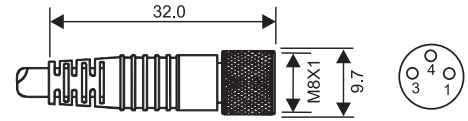

Brown = Pin 1
Blue = Pin 3
Black = Pin 4

Order P/N:
RC08-AFM030-0120C10A (2m length)
RC08-AFM030-0150C10A (5m length)

ORDERING INFORMATION

9 C 1 0 - 0 0 0 - □ □ □

Connection Options

0 - 9 ft PVC cable
3 - 8mm quick connect male pigtail*
**Mates with cordsets shown above*

Switch [†] Type	Description	Function	Switching Voltage	Switching Current	Switching Power	Voltage Drop	**Magnetic Sensitivity
02	Reed Switch for PLC's, Red LED (current limiting)	Normally Open SPST	5 - 120V AC/DC 50/60 Hz	0.03 Amps Max. 0.001 Amps Min.	4 watts Max.	5.0 Volts @ 5mA	85 Ga.
31	Electronic for Reed Magnet, Yel LED & Sourcing	Normally Open PNP	5 - 28 VDC	0.5 Amps Max.	14 watts Max.	.5 Volts @ 500mA	40 Ga.
32	Electronic for Reed Magnet, Red LED & Sinking	Normally Open NPN	5 - 28 VDC	0.5 Amps Max.	14 watts Max.	.5 Volts @ 500mA	40 Ga.

**Minimum gauss rating required for proper operation. Size of sensing area depends upon size and strength of magnet and thickness of cylinder wall.

Ordering Example: 9C10-000-032

9 ft. PVC cable, electronic for reed magnet, Red LED, sinking, NPN, 5 - 28 VDC



**canfield
connector**

9D SERIES
REED & ELECTRONIC
MAGNETIC SENSORS FOR
UNIVERSAL APPLICATIONS

GENERAL DESCRIPTION

The Canfield Connector 9D Series is a universal, ultra-small, magnetic proximity switch available in both solid state electronic and reed styles. These sensors are designed to fit the most stringent space requirements by use of a standard .250 inch dovetail slot. Many other mounting options are also available. The electronic sensor exhibits greater sensitivity to magnetism with reduced dead-band and hysteresis as compared to competitive devices. The reed sensor offers a wide operating voltage range. The molded switch has an on board indicator light that can be viewed from wide angles. Standard connection to the sensor is provided by a 9 ft. PVC or 8mm quick connect male pigtail. The rugged switch is shipped with mounting hardware ready for installation.



DIMENSIONAL DATA

All dimensions are in millimeters unless otherwise noted.

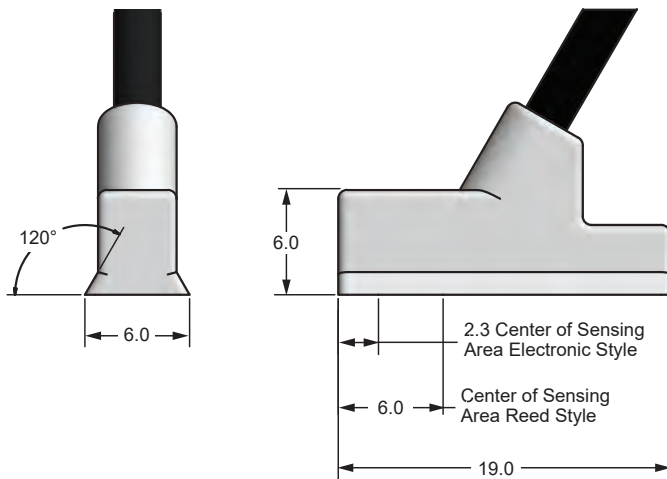

CONNECTION OPTION

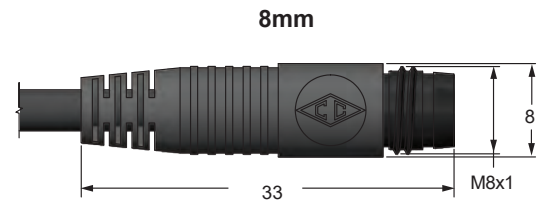

MOUNTING / CLAMP STYLES

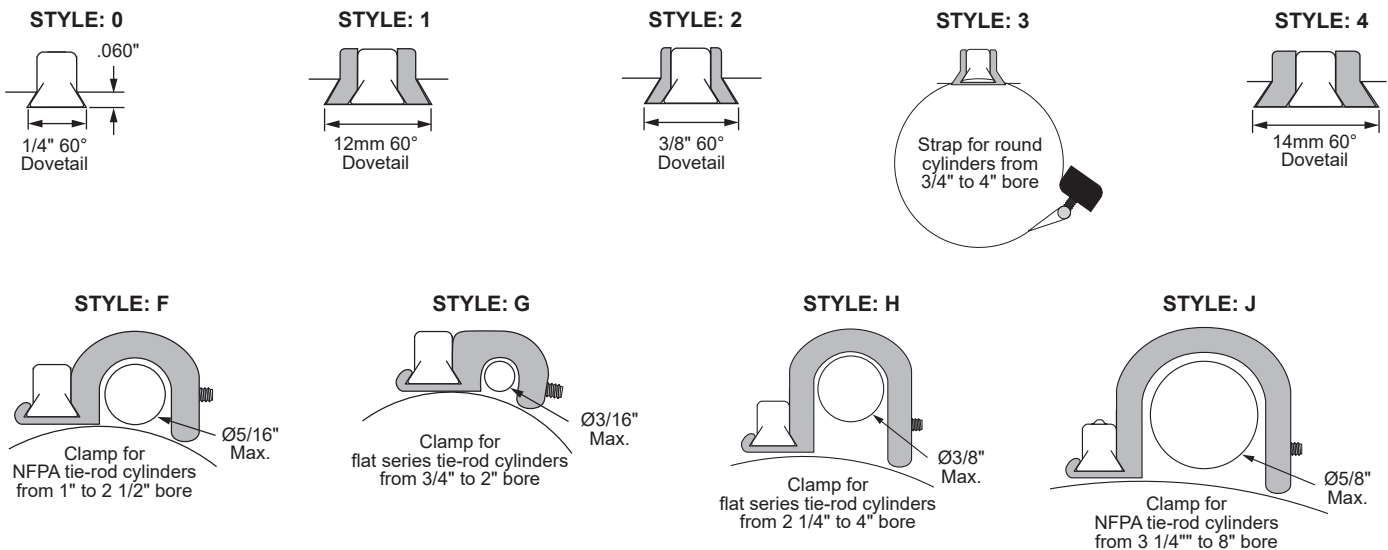

TECHNICAL DATA

Switch Type / Tech. Specs.	See Ordering Information†
Sensitivity / Orientation	Electronic: 25 Gauss Parallel Reed: 85 Gauss Parallel (measured from sensor surface)
Shock	Up to 30G (11ms) Reed Only (not applicable for electronics)
Vibration	Up to 20G (10-55 Hz) Reed only
Materials	Cable: PVC House: PA, TPU
Temperature Range	-20° to +80°C
Environmental Protection	Designed for IP 67 / NEMA 6
Cable Diameter	2.7mm
Wire Gauge	26 AWG standard

(ADDITIONAL) MATING CORDSETS / PIN CONFIGURATION

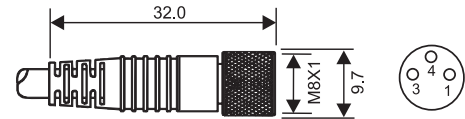

Brown = Pin 1
Blue = Pin 3
Black = Pin 4

Order P/N:

RC08-AFM030-0120C10A (2m length)
RC08-AFM030-0150C10A (5m length)

GROOVE DETAILS

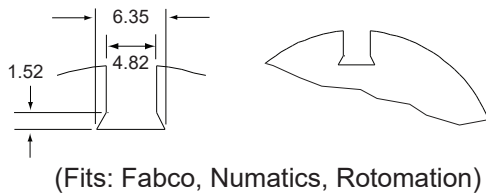

ORDERING INFORMATION

9 D 1 0 - [] 0 0 - [] [] []

Mounting / Clamp Styles

- 0 - 1/4" 60° dovetail (standard)
- 1 - 12mm 60° dovetail adapter
- 2 - 3/8" 60° dovetail adapter
- 3 - Round cylinder clamp 3/4" - 4" bore
- 4 - 14mm 60° dovetail adapter
- F - NFPA tie-rod cylinder clamp 1" - 2 1/2" bore
- G - Flat series cylinder clamp 3/4" - 2" bore
- H - Flat series cylinder clamp 2 1/4" - 4" bore
- J - NFPA tie-rod cylinder clamp 3 1/4" - 8" bore

Connection Options

- 0 - 9 ft PVC cable
- 3 - 8mm quick connect male pigtail*

*Mates with cordsets shown above

Switch† Type	Description	Function	Switching Voltage	Switching Current	Switching Power	Voltage Drop	Magnetic Sensitivity
01	Reed Switch	Normally Open SPST	0 - 120V AC/DC 50/60 Hz	0.25 Amps Max.	5 watts Max.	0 Volts	85 Ga.
02	Reed Switch for PLC's, Red LED (current limiting)	Normally Open SPST	5 - 120V AC/DC 50/60 Hz	0.03 Amps Max. 0.001 Amps Min.	4 watts Max.	5.0 Volts @ 5mA	85 Ga.
31	Electronic for Reed Magnet, Yel LED & Sourcing	Normally Open PNP	5 - 28 VDC	0.2 Amps Max.	4.8 watts Max.	1.0 Volts	25 Ga.
32	Electronic for Reed Magnet, Red LED & Sinking	Normally Open NPN	5 - 28 VDC	0.2 Amps Max.	4.8 watts Max.	1.0 Volts	25 Ga.

Ordering Example: 9D10-000-002

1/4" dovetail, 9 ft. PVC cable, reed switch for PLC's with
LED, SPST, normally open, 5 - 120V AC/DC 50/60 Hz

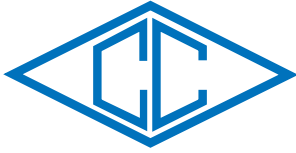

**canfield
connector**

9E SERIES
REED & ELECTRONIC
MAGNETIC SENSORS FOR
UNIVERSAL APPLICATIONS

GENERAL DESCRIPTION

The Canfield Connector 9E Series is a universal, ultra-small, magnetic proximity switch available in both solid state electronic and reed styles. These sensors are designed to fit the most stringent space requirements by use of a standard .250 inch dovetail slot. Many other mounting options are also available. The electronic sensor exhibits greater sensitivity to magnetism with reduced dead-band and hysteresis as compared to competitive devices. The reed sensor offers a wide operating voltage range. The molded switch has an on board indicator light that can be viewed from wide angles. Standard connection to the sensor is provided by a 9 ft. PVC or 8mm quick connect male pigtail. The rugged switch is shipped with mounting hardware ready for installation.



DIMENSIONAL DATA

All dimensions are in millimeters unless otherwise noted.

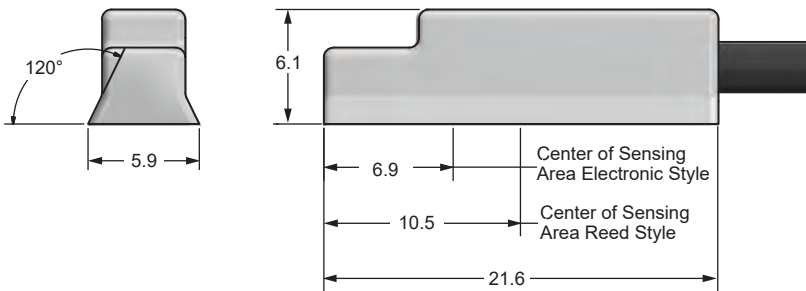

CONNECTION OPTION

8mm

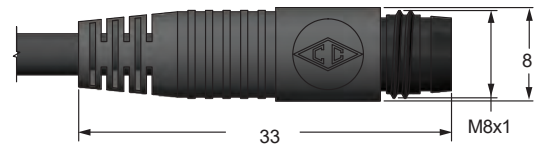

MOUNTING / CLAMP STYLES

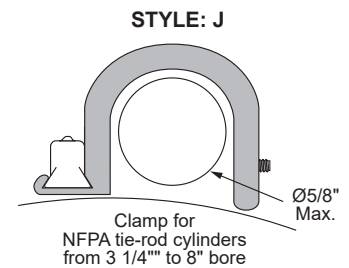
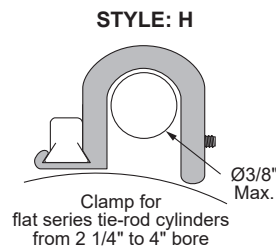
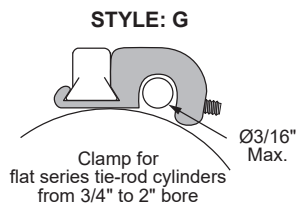
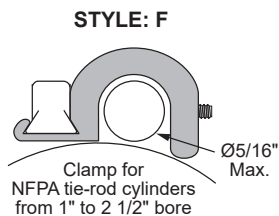
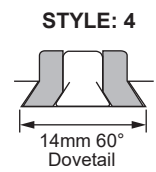
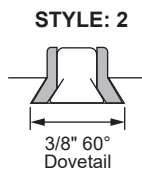
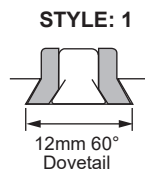
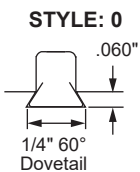

TECHNICAL DATA

Switch Type / Tech. Specs.	See Ordering Information [†]
Sensitivity / Orientation	Electronic: 25 Gauss Parallel Reed: 85 Gauss Parallel (measured from sensor surface)
Shock	Up to 30G (11ms) Reed Only (not applicable for electronics)
Vibration	Up to 20G (10-55 Hz) Reed only
Materials	Cable: PVC House: PA, TPU
Temperature Range	-20° to +80°C
Environmental Protection	Designed for IP 67 / NEMA 6
Cable Diameter	2.7mm
Wire Gauge	26 AWG standard

(ADDITIONAL) MATING CORDSETS / PIN CONFIGURATION

8mm female molded locking connector

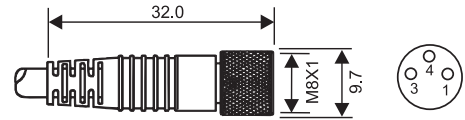

Brown = Pin 1
Blue = Pin 3
Black = Pin 4

Order P/N:

RC08-AFM030-0120C10A (2m length)
RC08-AFM030-0150C10A (5m length)

GROOVE DETAILS

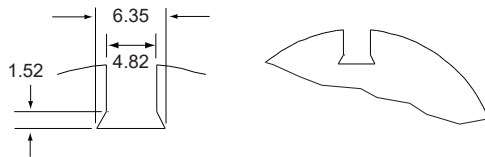

(Fits: Fabco, Numatics, Rotomation)

ORDERING INFORMATION

9 E 1 0 - [] 0 0 - [] [] []

Mounting / Clamp Styles

- 0 - 1/4" 60° dovetail (standard)
- 1 - 12mm 60° dovetail adapter
- 2 - 3/8" 60° dovetail adapter
- 3 - Round cylinder clamp 3/4" - 4" bore
- 4 - 14mm 60° dovetail adapter
- F - NFPA tie-rod cylinder clamp 1" - 2 1/2" bore
- G - Flat series cylinder clamp 3/4" - 2" bore
- H - Flat series cylinder clamp 2 1/4" - 4" bore
- J - NFPA tie-rod cylinder clamp 3 1/4" - 8" bore

Connection Options

- 0 - 9 ft PVC cable
- 3 - 8mm quick connect male pigtail*

*Mates with cordsets shown above

Switch [†] Type	Description	Function	Switching Voltage	Switching Current	Switching Power	Voltage Drop	Magnetic Sensitivity
01	Reed Switch	Normally Open SPST	0 - 120V AC/DC 50/60 Hz	0.25 Amps Max.	5 watts Max.	0 Volts	85 Ga.
02	Reed Switch for PLC's, Red LED (current limiting)	Normally Open SPST	5 - 120V AC/DC 50/60 Hz	0.03 Amps Max. 0.001 Amps Min.	4 watts Max.	5.0 Volts @ 5mA	85 Ga.
31	Electronic for Reed Magnet, Yel LED & Sourcing	Normally Open PNP	5 - 28 VDC	0.2 Amps Max.	4.8 watts Max.	1.0 Volts	25 Ga.
32	Electronic for Reed Magnet, Red LED & Sinking	Normally Open NPN	5 - 28 VDC	0.2 Amps Max.	4.8 watts Max.	1.0 Volts	25 Ga.

Ordering Example: 9E10-000-002

1/4" dovetail, 9 ft. PVC cable, reed switch for PLC's with LED, SPST, normally open, 5 - 120V AC/DC 50/60 Hz



**canfield
connector**

9F SERIES
REED & ELECTRONIC
MAGNETIC SENSORS FOR
4MM "T" SLOT APPLICATIONS

GENERAL DESCRIPTION

The Canfield Connector 9F Series is a universal, ultra-small, magnetic proximity switch available in both solid state electronic and reed styles. These sensors are designed to fit the most stringent space requirements by using a 4mm "T" slot. The electronic sensor exhibits greater sensitivity to magnetism with reduced dead-band and hysteresis as compared to competitive devices. The reed sensor offers a wide operating voltage range. The molded switch has an on board indicator light that can be viewed from wide angles. Standard connection to the sensor is provided by a 9 ft. PVC or 8mm quick connect male pigtail. The rugged switch is shipped with mounting hardware ready for installation.



DIMENSIONAL DATA

All dimensions are in millimeters unless otherwise noted.

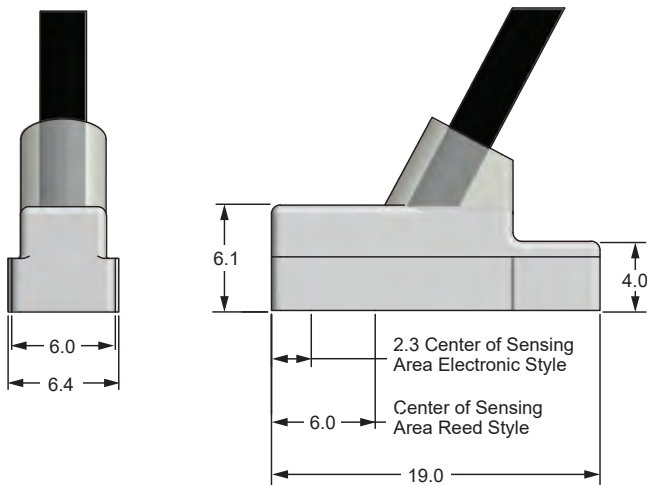

CONNECTION OPTION

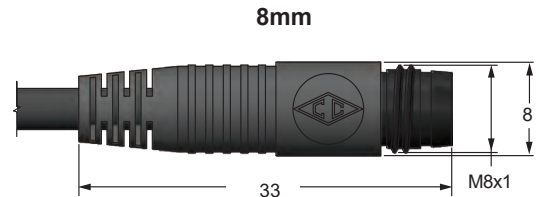

GROOVE DETAILS

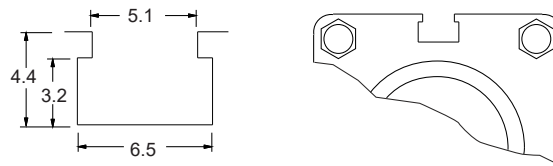

(Fits: Fabco, Festo, Numatics, Rotomation)

TECHNICAL DATA

Switch Type / Tech. Specs.	See Ordering Information†
Sensitivity / Orientation	Electronic: 25 Gauss Parallel Reed: 85 Gauss Parallel (measured from sensor surface)
Shock	Up to 30G (11mS) Reed Only (not applicable for electronics)
Vibration	Up to 20G (10-55 Hz) Reed only
Materials	Cable: PVC House: PA, TPU
Temperature Range	-20° to +80°C
Environmental Protection	Designed for IP 67 / NEMA 6
Cable Diameter	2.7mm
Wire Gauge	26 AWG standard

(ADDITIONAL) MATING CORDSETS / PIN CONFIGURATION

8mm female molded locking connector

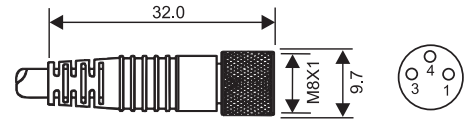

Brown = Pin 1
Blue = Pin 3
Black = Pin 4

Order P/N:

RC08-AFM030-0120C10A (2m length)
RC08-AFM030-0150C10A (5m length)

ORDERING INFORMATION

9 F 1 0 - 0 0 0 - □ □ □

Connection Options

0 - 9 ft PVC cable
3 - 8mm quick connect male pigtail*
**Mates with cordsets shown above*

Switch† Type	Description	Function	Switching Voltage	Switching Current	Switching Power	Voltage Drop	Magnetic Sensitivity
01	Reed Switch	Normally Open SPST	0 - 120V AC/DC 50/60 Hz	0.25 Amps Max.	5 watts Max.	0 Volts	85 Ga.
02	Reed Switch for PLC's, Red LED (current limiting)	Normally Open SPST	5 - 120V AC/DC 50/60 Hz	0.03 Amps Max. 0.001 Amps Min.	4 watts Max.	5.0 Volts @ 5mA	85 Ga.
31	Electronic for Reed Magnet, Yel LED & Sourcing	Normally Open PNP	5 - 28 VDC	0.2 Amps Max.	4.8 watts Max.	1.0 Volts	25 Ga.
32	Electronic for Reed Magnet, Red LED & Sinking	Normally Open NPN	5 - 28 VDC	0.2 Amps Max.	4.8 watts Max.	1.0 Volts	25 Ga.

Ordering Example: 9F10-000-002

9 ft. PVC cable, reed switch for PLC's with LED,
SPST, normally open, 5 - 120V AC/DC 50/60 Hz



canfield
connector

9H SERIES
REED & ELECTRONIC
MAGNETIC SENSORS FOR
4.2MM "T" SLOT APPLICATIONS

GENERAL DESCRIPTION

The Canfield Connector 9H Series is a profile mounting type switch that fits in a 4mm X 4mm square groove which normally is designed into an aluminum extrusion type linear actuator. Available in reed or electronic versions, the 9H is also available with a 9 ft. PVC or 8mm quick connect male pigtail. The switch is IP-67 which is dust tight and water resistant.

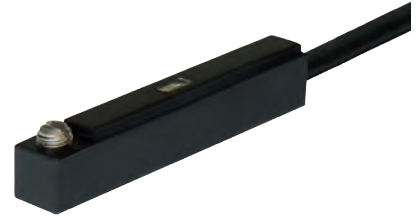

DIMENSIONAL DATA

All dimensions are in millimeters unless otherwise noted.

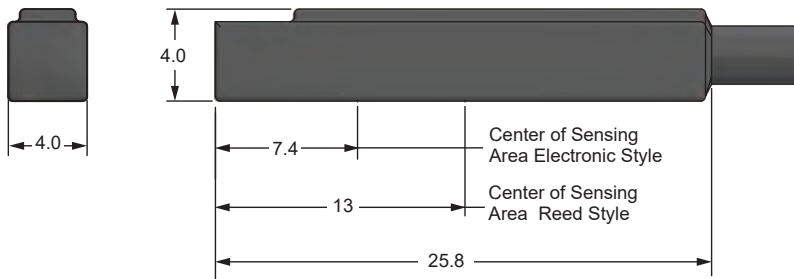

CONNECTION OPTION

8mm

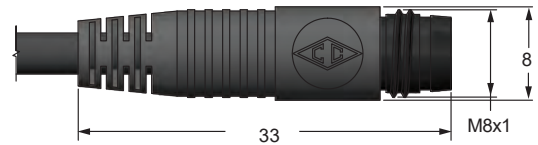

GROOVE DETAILS

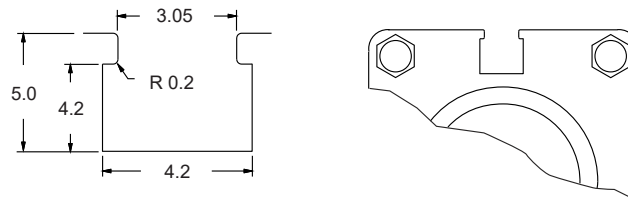

(Fits: 4x4 groove)

TECHNICAL DATA

Switch Type / Tech. Specs.	See Ordering Information [†]
Sensitivity / Orientation	Electronic: 25 Gauss Parallel Reed: 85 Gauss Parallel (measured from sensor surface)
Shock	Up to 30G (11mS) Reed Only (not applicable for electronics)
Vibration	Up to 20G (10-55 Hz) Reed only
Materials	Cable: PVC House: ABS
Temperature Range	-20° to +80°C
Environmental Protection	Designed for IP 67 / NEMA 6
Cable Diameter	2.8mm
Wire Gauge	26 AWG standard

(ADDITIONAL) MATING CORDSETS / PIN CONFIGURATION

8mm female molded locking connector

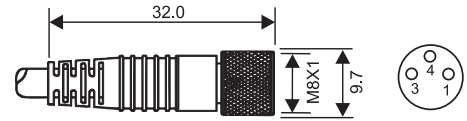

Brown = Pin 1
Blue = Pin 3
Black = Pin 4

Order P/N:

RC08-AFM030-0120C10A (2m length)
RC08-AFM030-0150C10A (5m length)

ORDERING INFORMATION

9 H 1 0 - 0 0 0 - □ □ □

Connection Options

0 - 9 ft PVC cable
3 - 8mm quick connect male pigtail*
**Mates with cordsets shown above*

Switch [†] Type	Description	Function	Switching Voltage	Switching Current	Switching Power	Voltage Drop	Magnetic Sensitivity
02	Reed Switch with Red LED	Normally Open SPST	5 - 120V AC/DC	0.1 Amps Max.	10 watts Max.	2.5 Volts @ 100mA	60 Ga.
31	Electronic for Reed Magnet, with Grn LED & Sourcing	Normally Open PNP	5 - 28 VDC	0.2 Amps Max.	6 watts Max.	.5 Volts @ 200 mA	40 Ga.
32	Electronic for Reed Magnet, with Red LED & Sinking	Normally Open NPN	5 - 28 VDC	0.2 Amps Max.	6 watts Max.	.5 Volts @ 200 mA	40 Ga.

Ordering Example: 9H10-000-002

9 ft. PVC cable, reed switch with red LED, SPST, 5 - 120V AC/DC 50/60 Hz



**canfield
connector**

9K SERIES
REED & ELECTRONIC
MAGNETIC SENSORS FOR
4.2MM "U" GROOVE APPLICATIONS

GENERAL DESCRIPTION

The Canfield Connector 9K Series is a profile mounting type switch that fits in a 4.2mm "U" groove which normally is designed into an aluminum extrusion type linear actuator. Available in reed or electronic versions, the 9K is also available with a 9 ft. PVC or 8mm quick connect male pigtail. The switch is IP67 which is dust tight and water resistant.



DIMENSIONAL DATA

All dimensions are in millimeters unless otherwise noted.

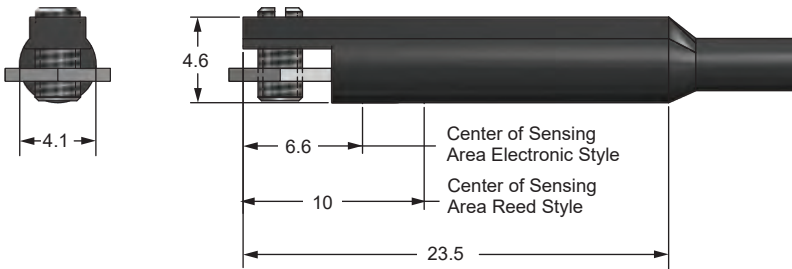

CONNECTION OPTION

8mm

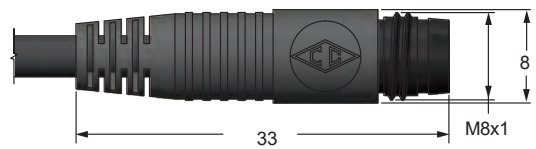

GROOVE DETAILS

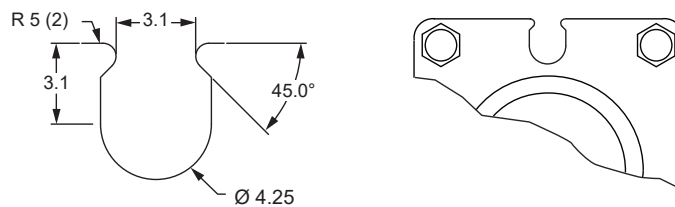

(Fits: Mindman, Koganei)

TECHNICAL DATA

Switch Type / Tech. Specs.	See Ordering Information [†]
Sensitivity / Orientation	Electronic: 25 Gauss Parallel Reed: 85 Gauss Parallel (measured from sensor surface)
Shock	Up to 30G (11mS) Reed Only (not applicable for electronics)
Vibration	Up to 20G (10-55 Hz) Reed only
Materials	Cable: PVC House: PBT
Temperature Range	-20° to +80°C
Environmental Protection	Designed for IP 67 / NEMA 6
Cable Diameter	2.8mm
Wire Gauge	26 AWG standard

(ADDITIONAL) MATING CORDSETS / PIN CONFIGURATION

8mm female molded locking connector

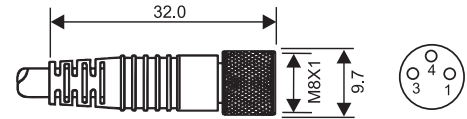

Brown = Pin 1
Blue = Pin 3
Black = Pin 4

Order P/N:

RC08-AFM030-0120C10A (2m length)
RC08-AFM030-0150C10A (5m length)

ORDERING INFORMATION

9 K 10 - 0 0 0 - □ □ □

Connection Options

0 - 9 ft PVC cable
3 - 8mm quick connect male pigtail*
**Mates with cordsets shown above*

Switch [†] Type	Description	Function	Switching Voltage	Switching Current	Switching Power	Voltage Drop	Magnetic Sensitivity
02	Reed Switch with Red LED	Normally Open SPST	5 - 120V AC/DC	0.03 Amps Max.	4 watts Max.	2.5 Volts	60 Ga.
31	Electronic for Reed Magnet, with Grn LED & Sourcing	Normally Open PNP	5 - 28 VDC	0.2 Amps Max.	4.8 watts Max.	.5 Volts	40 Ga.
32	Electronic for Reed Magnet, with Red LED & Sinking	Normally Open NPN	5 - 28 VDC	0.2 Amps Max.	4.8 watts Max.	.5 Volts	40 Ga.

Ordering Example: 9K10-000-002

9 ft. PVC cable, reed switch with red LED,
SPST, 5 - 120V AC/DC 50/60 Hz

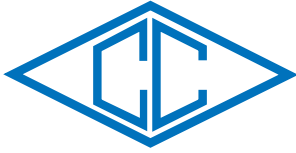

**canfield
connector**

9M50 SERIES
REED & ELECTRONIC
MAGNETIC SENSORS FOR
6.5MM "D" GROOVE APPLICATIONS

GENERAL DESCRIPTION

The Canfield Connector 9M50 Series is a compact full featured magnetic proximity switch designed to fit a "D" shaped groove detail designed into linear actuators. The innovative design allows the switch to be inserted anywhere along the linear actuator and then rotated and locked into position. When installed the switch lies flat against the cylinder housing and does not protrude beyond the cylinder face making installations neat and clean. The fully encapsulated switch is offered in reed, and electronic styles in either NPN or PNP. The robust polyurethane encapsulated design meets IP67, NEMA 6 environmental protection. Voltage ranges are available from 0 to 120 VAC/DC in multiple versions. Standard connection is provided by a 9 ft. PVC or 8mm quick connect male pigtail and is proudly made in the U.S.A.



DIMENSIONAL DATA

All dimensions are in millimeters unless otherwise noted.

CONNECTION OPTION

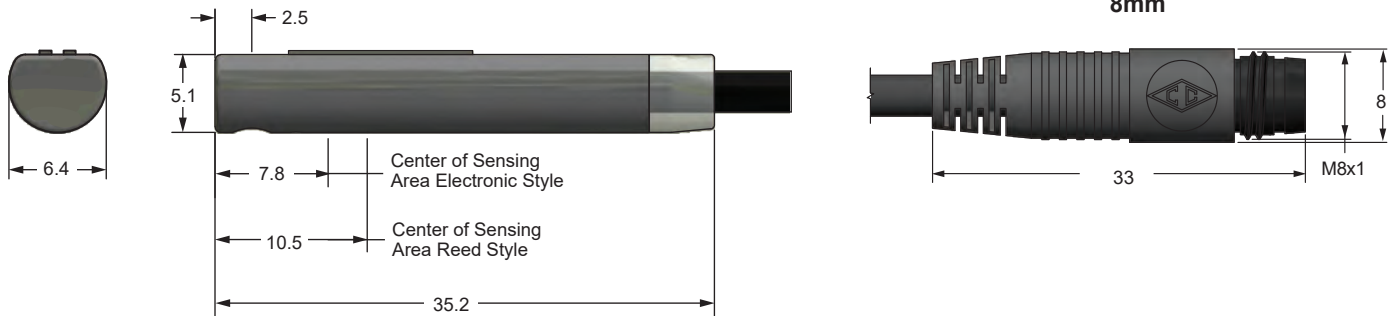

GROOVE DETAILS

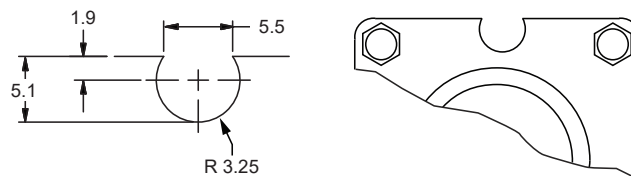

(Fits: Norgren)

TECHNICAL DATA

Switch Type / Tech. Specs.	See Ordering Information [†]
Sensitivity / Orientation	Electronic: 25 Gauss Parallel Reed: 85 Gauss Parallel (measured from sensor surface)
Shock	Up to 30G (11mS) Reed Only (not applicable for electronics)
Vibration	Up to 20G (10-55 Hz) Reed only
Materials	Cable: PVC House: PEI, TPU
Temperature Range	-20° to +80°C
Environmental Protection	Designed for IP 67 / NEMA 6
Cable Diameter	2.7mm
Wire Gauge	26 AWG standard

(ADDITIONAL) MATING CORDSETS / PIN CONFIGURATION

8mm female molded locking connector

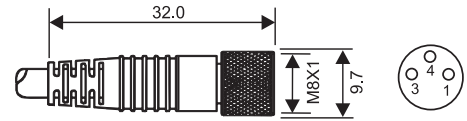

Brown = Pin 1
Blue = Pin 3
Black = Pin 4

Order P/N:
RC08-AFM030-0120C10A (2m length)
RC08-AFM030-0150C10A (5m length)

ORDERING INFORMATION

9 M 5 0 1 0 - 0 0 0 -

Connection Options

0 - 9 ft PVC cable
3 - 8mm quick connect male pigtail*
**Mates with cordsets shown above*

Switch [†] Type	Description	Function	Switching Voltage	Switching Current	Switching Power	Voltage Drop	**Magnetic Sensitivity
01	Reed Switch	Normally Open SPST	0 - 120V AC/DC 50/60 Hz	0.25 Amps Max.	5 watts Max.	0 Volts	85 Ga.
02	Reed Switch for PLC's Red LED (current limiting)	Normally Open SPST	5 - 120V AC/DC 50/60 Hz	0.03 Amps Max. 0.001 Amps Min.	4 watts Max.	3.5 Volts	85 Ga.
31	Electronic for Reed Magnet, Yel LED & Sourcing	Normally Open PNP	5 - 28 VDC	0.2 Amps Max.	4.8 watts Max.	1.0 Volts	25 Ga.
32	Electronic for Reed Magnet, Red LED & Sinking	Normally Open NPN	5 - 28 VDC	0.2 Amps Max.	4.8 watts Max.	1.0 Volts	25 Ga.

[†]Minimum gauss rating required for proper operation. Size of sensing area depends upon size and strength of magnet and thickness of cylinder wall.

Ordering Example: 9M5010-000-002

9 ft. PVC cable, reed switch with Red LED, SPST, 5 - 120V AC/DC 50/60 Hz



**canfield
connector**

9Q SERIES
REED & ELECTRONIC
MAGNETIC SENSORS FOR
UNIVERSAL "T" SLOT APPLICATIONS

GENERAL DESCRIPTION

The Canfield Connector 9Q Series is a magnetic proximity switch that is engineered to fit into extruded actuators that are made with a "T" slot. The unique design of the 9Q enables it to be installed anywhere along the slot and assembled in place without taking off the actuator end-cap. The rugged polyurethane encapsulated switch features an innovative design that incorporates a hard nylon shell. The switches are available in reed or electronic sensing and features a standard on board indicator light. Offered as a flying lead or 8mm quick connect, the sensors are quickly and easily wired in to any application. The sensors meet NEMA 6 / IP67 environmental specifications and are corrosion and wash-down compatible. This sensor is proudly made in the USA.



DIMENSIONAL DATA

All dimensions are in millimeters unless otherwise noted.

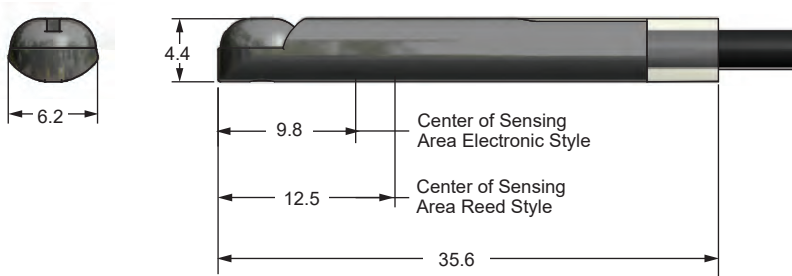

CONNECTION OPTION

8mm

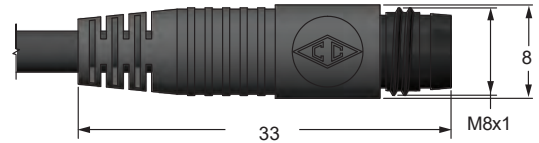

GROOVE DETAILS

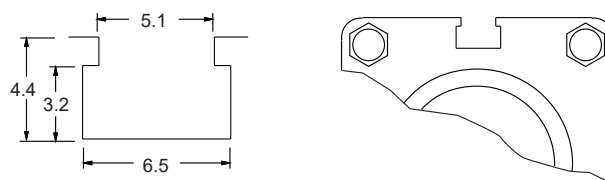

(Fits: Parker, Fabco, Festo, Numatics, Rotomation)

TECHNICAL DATA

Switch Type / Tech. Specs.	See Ordering Information [†]
Sensitivity / Orientation	Electronic: 25 Gauss Parallel Reed: 85 Gauss Parallel (measured from sensor surface)
Shock	Up to 30G (11mS) Reed Only (not applicable for electronics)
Vibration	Up to 20G (10-55 Hz) Reed only
Materials	Cable: PVC House: PEI, TPU
Temperature Range	-20° to +80°C
Environmental Protection	Designed for IP 67 / NEMA 6
Cable Diameter	2.7mm
Wire Gauge	26 AWG standard

(ADDITIONAL) MATING CORDSETS / PIN CONFIGURATION

8mm female molded locking connector

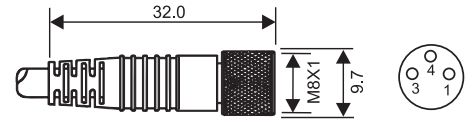

Brown = Pin 1
Blue = Pin 3
Black = Pin 4

Order P/N:

RC08-AFM030-0120C10A (2m length)
RC08-AFM030-0150C10A (5m length)

ORDERING INFORMATION

9Q10-000-□□□

Connection Options

0 - 9 ft PVC cable
3 - 8mm quick connect male pigtail*
*Mates with cordsets shown above

Switch [†] Type	Description	Function	Switching Voltage	Switching Current	Switching Power	Voltage Drop	Magnetic Sensitivity
01	Reed Switch	Normally Open SPST	0 - 120V AC/DC 50/60 Hz	0.25 Amps Max.	5 watts Max.	0 Volts	85 Ga.
02	Reed Switch for PLC's, Red LED (current limiting)	Normally Open SPST	5 - 120V AC/DC 50/60 Hz	0.03 Amps Max. 0.001 Amps Min.	4 watts Max.	5.0 Volts @ 5mA	85 Ga.
31	Electronic for Reed Magnet, Yel LED & Sourcing	Normally Open PNP	5 - 28 VDC	0.2 Amps Max.	4.8 watts Max.	1.0 Volts	25 Ga.
32	Electronic for Reed Magnet, Red LED & Sinking	Normally Open NPN	5 - 28 VDC	0.2 Amps Max.	4.8 watts Max.	1.0 Volts	25 Ga.

Ordering Example: 9Q10-000-002

9 ft. PVC cable, reed switch for PLC's with
LED, SPST, normally open, 5 - 120V AC/DC 50/60 Hz



**canfield
connector**

9U SERIES
REED & ELECTRONIC
MAGNETIC SENSORS FOR
"T" SLOT APPLICATIONS

GENERAL DESCRIPTION

The Canfield Connector 9U Series is a compact full featured magnetic proximity switch designed to fit a Fabco, Festo, Numatics, Parker and SMC T-slot groove detail designed into linear actuators. The innovative top down design allows the switch to be inserted anywhere along the linear actuator and tightened into position. When installed the switch lies flush against the cylinder housing making installations neat and clean. The fully encapsulated switch is offered in reed, and electronic styles in either NPN or PNP. The robust encapsulated design meets IP67, EN60529, NEMA 6 environmental protection. Voltage ranges are available for reed version from 0 to 240 VAC/DC and 5-30 VDC in electronic versions. Standard connection is provided by a 9 ft. PUR wire lead or 8mm quick connect male pigtail.



DIMENSIONAL DATA

All dimensions are in millimeters unless otherwise noted.

CONNECTION OPTION

8mm

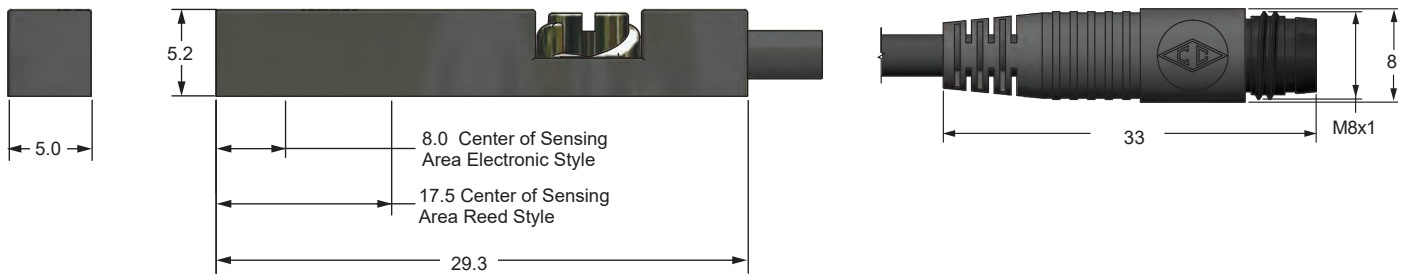

GROOVE DETAILS

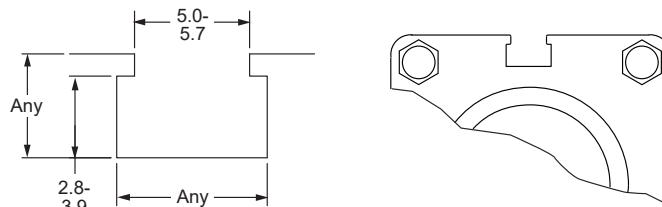

(Fits: Fabco, Festo, Numatics, Parker, SMC)

TECHNICAL DATA

Switch Type / Tech. Specs.	See Ordering Information†
Sensitivity / Orientation	Electronic: 40 Gauss Parallel Reed: 60 Gauss Parallel (measured from sensor surface)
Shock	Up to 50G (11mS)
Vibration	Up to 9G
Materials	Cable: PUR House: PA
Temperature Range	-10° to +70°C
Environmental Protection	Designed for IP 67 / NEMA 6
Cable Diameter	2.9mm
Wire Gauge	26 AWG standard

(ADDITIONAL) MATING CORDSETS / PIN CONFIGURATION

8mm female molded locking connector

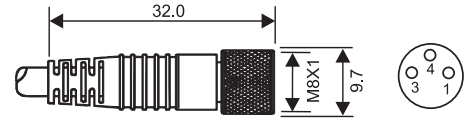

Brown = Pin 1
Blue = Pin 3
Black = Pin 4

Order P/N:

RC08-AFM030-0120C10A (2m length)
RC08-AFM030-0150C10A (5m length)

ORDERING INFORMATION

9U10-000-□□□

Connection Options

0 - 9 ft PVC cable
3 - 8mm quick connect male pigtail*
**Mates with cordsets shown above*

Switch† Type	Description	Function	Switching Voltage	Switching Current	Switching Power	Voltage Drop	Magnetic Sensitivity
02	Reed Switch with Red LED	Normally Open SPST	5 - 240V AC/DC	0.1 Amps Max.	10 watts Max.	2.65 Volts @ 100mA	60 Ga.
31	Electronic for Reed Magnet, with Grn LED & Sourcing	Normally Open PNP	5 - 30 VDC	0.1 Amps Max.	3 watts Max.	.5 Volts @ 100 mA	40 Ga.
32	Electronic for Reed Magnet, with Red LED & Sinking	Normally Open NPN	5 - 30 VDC	0.1 Amps Max.	3 watts Max.	.5 Volts @ 100 mA	40 Ga.

Ordering Example: 9U10-000-002

9 ft. PVC cable, reed switch with red LED,
SPST, 5 - 240V AC/DC 50/60 Hz



**canfield
connector**

CS SERIES
ALL THREADED
MAGNETIC SENSORS FOR
UNIVERSAL APPLICATIONS

GENERAL DESCRIPTION

The Canfield Connector CS Series Cylindrical Threaded Mount Sensor is a rugged and compact magnetic sensor set within a miniature encapsulated Stainless Steel M8 threaded housing. Available in reed or electronic sensing, the CS sensor can sense magnets or magnetic objects in industrial machinery and mobile equipment. Typically used where greater sensing distance is required, the CS sensor changes state in the presence of a magnetic field. Electrical output for the CS is normally open, with sinking or sourcing outputs for the electronic versions. Input voltages available are 0 to 120 VAC/DC .5 Amp maximum for the reed and 5-24 VDC 0.2 Amp maximum for the electronic versions. The sensor is made of a Stainless Steel body, TPU encapsulant and has PVC wire standard and is NEMA 6. Temperature ranges are -20° to 80°C. The CS Series is proudly made in the U.S.A.



DIMENSIONAL DATA

All dimensions are in millimeters unless otherwise noted.

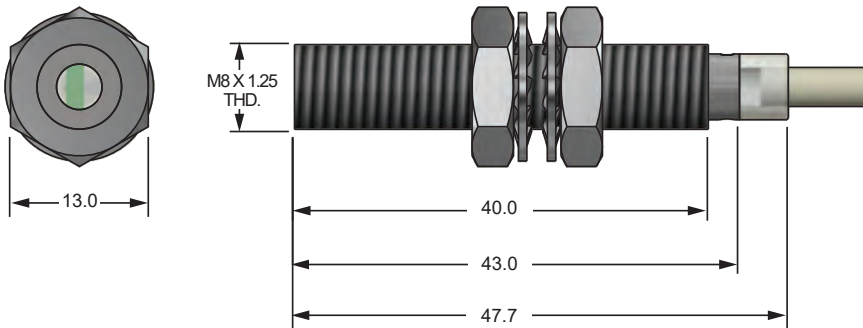

CONNECTION OPTIONS

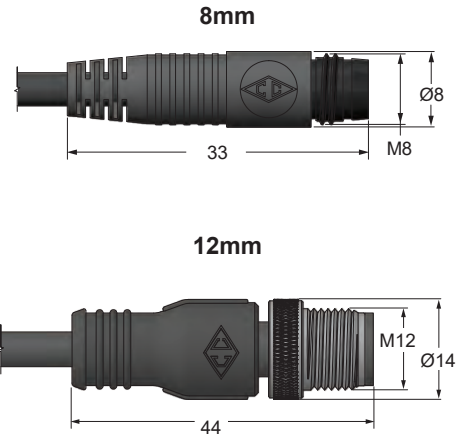

MOUNTING ORIENTATION

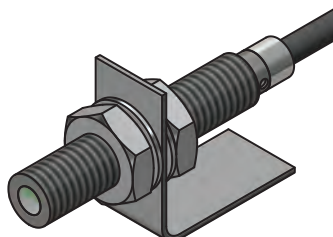

TECHNICAL DATA

Switch Type / Tech. Specs.	See Ordering Information [†]
Sensitivity / Orientation	Electronic: 25 Gauss Parallel Reed: 85 Gauss Parallel (measured from sensor surface)
Shock	Up to 30G (11ms) Reed Only (not applicable for electronics)
Vibration	Up to 20G (10-55 Hz) Reed only
Materials	Cable: PVC House: 300 Series Stainless Steel, TPU
Temperature Range	-20° to +80°C
Environmental Protection	Designed for IP 67 / NEMA 6
Cable Diameter	2.7mm
Wire Gauge	24 AWG standard

(ADDITIONAL) MATING CORDSETS / PIN CONFIGURATION

8mm female molded locking connector

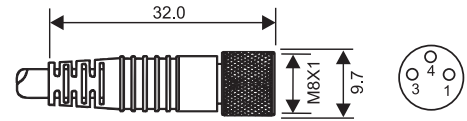

Brown = Pin 1
Blue = Pin 3
Black = Pin 4

Order P/N:
RC08-AFM030-0120C10A (2m length)
RC08-AFM030-0150C10A (5m length)

12mm female molded locking connector (3 pole) 250VAC/DC 4 Amps max.

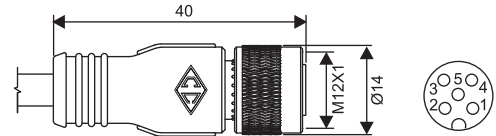

Brown = Pin 1
Blue = Pin 3
Black = Pin 4
N/C = Pin 2
N/C = Pin 5

Order P/N:
RC12-AFM030-0120C10A (2m length)
RC12-AFM030-0150C10A (5m length)

ORDERING INFORMATION

CSM0810 - □ □ □ - 0 □

Connection Options

0 - 9 ft PVC cable
3 - 8mm quick connect male pigtail*
5 - 12mm quick connect male pigtail*
**Mates with cordsets shown above*

Special Packaging

A - Bulk
G - Individually Bagged

Switch [†] Type	Description	Function	Switching Voltage	Switching Current	Switching Power	Voltage Drop	Magnetic Sensitivity
01	Reed Switch	Normally Open SPST	0 - 120V AC/DC 50/60 Hz	0.5 Amps Max.	5 Watts Max.	0 Volts	85 Ga.
31	Electronic for Reed Magnet, No LED & Sourcing	Normally Open PNP	5 - 24 VDC	0.2 Amps Max.	4.8 Watts Max.	1.0 Volts	25 Ga.
32	Electronic for Reed Magnet, No LED & Sinking	Normally Open NPN	5 - 24 VDC	0.2 Amps Max.	4.8 Watts Max.	1.0 Volts	25 Ga.

Ordering Example: CSM0810-001-0A

9 ft. PVC cable, Reed Switch, Normally Open, 0-120V AC/DC 50/60 Hz, Bulk Packaged.



canfield
connector



EiS SERIES
ELECTRONIC
INCLINOMETER
SENSORS

GENERAL DESCRIPTION

The Canfield Connector Electronic Inclinator Sensor EiS is an instrument designed to measure angles of slope, tilt, or elevation of an object with respect to gravity based on an artificial horizon. Synonyms include tilt sensor, tilt switch, clinometer, slope sensor, slope gauge, level sensor, level meter, tiltmeter or pitch and roll sensor. The EiS Series is an all solid-state, MEMs device designed to measure tilt while reporting the data within 0.3 degrees accuracy +/- 85° with an analog output of .5 to 9.5 Volts DC, 4 -20mA. The unit features a miniature metal housing and is epoxy encapsulated for vibration, water and dust resistance and is rated up to IP 69K environmental rating. Available in 1 or 2 axis versions, the unit boasts a temperature drift of +/- 1° maximum with a temperature range of -40 to 85°C. The EiS Series is precisely calibrated to remove non-linearity in the sensing range. Applications for inclinometers such as the EiS Series include platform leveling, motion sensing, filter vibrations, boom angle sensing, cameras, machine arm angle sensing as well as mobile security systems. The unit comes with high quality 9 ft. PVC jacketed wire, other lengths and quick connections as options, and is mounted in place by use of two 4.2mm holes.



DIMENSIONAL DATA

All dimensions are in millimeters unless otherwise noted.

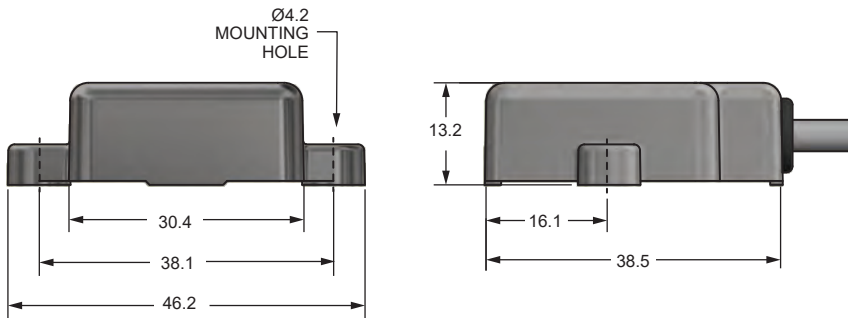

CONNECTION OPTIONS

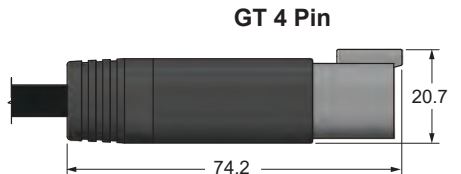
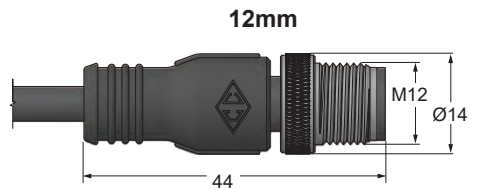
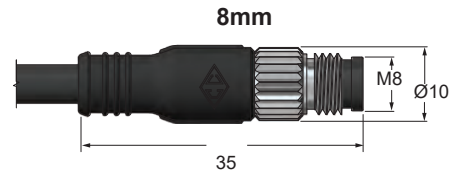

TECHNICAL DATA

Accuracy @ 20°C	0.3°
Environmental Protection	Up to IP 69K
Materials	Housing: Zinc die-cast Housing Finish: Black powder coat
Number of Axis	Single: 1 Dual: 2
Output Current	10 mA Maximum (Voltage Output Units)
Output Format	Analog
Output Type	0.5 - 4.5VDC 0.5 - 9.5 VDC 4 - 20 mA
Range	+/- 85°
Supply Voltage	12-24 VDC
Temperature Drift	+/- 1° Maximum
Temperature Range	-40° to +85°C
Cable Type	PVC (PUR on request. Consult Factory)
Wire Gauge	24 AWG

MOUNTING / SENSING ORIENTATION

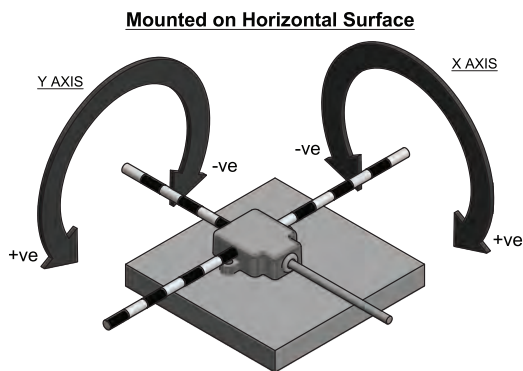

(ADDITIONAL) MATING CORDSETS / PIN CONFIGURATION

8mm female molded locking connector

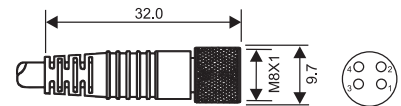

Brown = Pin 1
White = Pin 2
Blue = Pin 3
Black = Pin 4

Order P/N:
RC08-AFM040-0120C10A (2m length)
RC08-AFM040-0150C10A (5m length)

12mm female molded locking connector

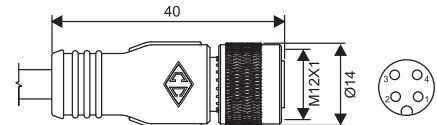

Brown = Pin 1
White = Pin 2
Blue = Pin 3
Black = Pin 4

Order P/N:
RC12-AFM040-0120C10A (2m length)
RC12-AFM040-0150C10A (5m length)

GT Deutsch style locking plug

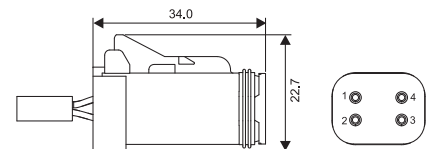

Brown = Pin 1
Blue = Pin 2
Black = Pin 3
Green = Pin 4

Order P/N:
GT0604-U000-1A (2m length)
GT0604-X000-1A (5m length)

ORDERING INFORMATION

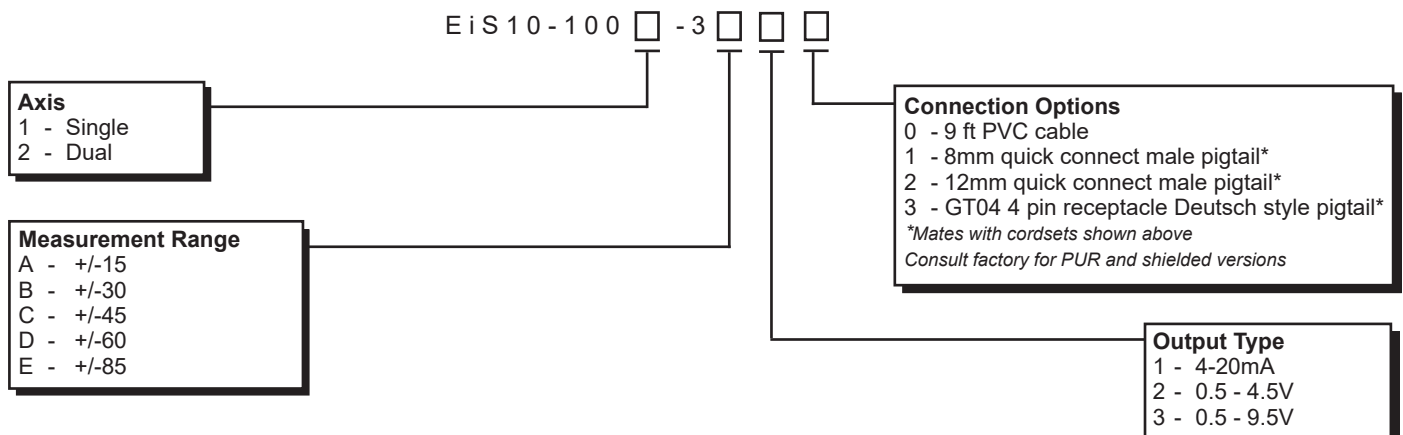

Ordering Example: EiS10-1001-3A10

Single Axis, +/-15 Range, 4-20mA, 9 ft. PVC cable.



canfield
connector



EiS SERIES
J1939 AND CANOPEN
ELECTRONIC
INCLINOMETER SENSORS

GENERAL DESCRIPTION

The Canfield Connector Electronic Inclinometer Sensor EiS is available in two versions, CANopen and SAE J1939 communication interfaces. The EiS CAN BUS versions feature dual axis output designed to measure angles of slope or tilt angles of an object with respect to gravity based on an artificial horizon. Synonyms include tilt sensor, tilt switch, clinometer, slope sensor, slope gauge, level sensor, level meter, tiltmeter or pitch and roll sensor. The EiS Series is an all solid-state, MEMS device designed to measure tilt while reporting the data via CANopen or SAE J1939 within 0.3 degrees accuracy +/- 90°. The unit features a miniature metal housing and is epoxy encapsulated for vibration, water and dust resistance and is rated up to IP 69K environmental rating. The unit boasts a temperature drift of +/- 1° maximum with a temperature range of -40 to 85°C. The EiS CAN BUS versions are precisely calibrated to remove non-linearity in the sensing range. Applications for inclinometers such as the EiS Series include platform leveling, motion sensing, filter vibrations, boom angle sensing, cameras, machine arm angle sensing, engine management as well as mobile security systems. The unit comes with high quality 9 ft. PVC jacketed wire, other lengths and quick connections as options, and is mounted in place by use of two 4.2mm holes.



DIMENSIONAL DATA

All dimensions are in millimeters unless otherwise noted.

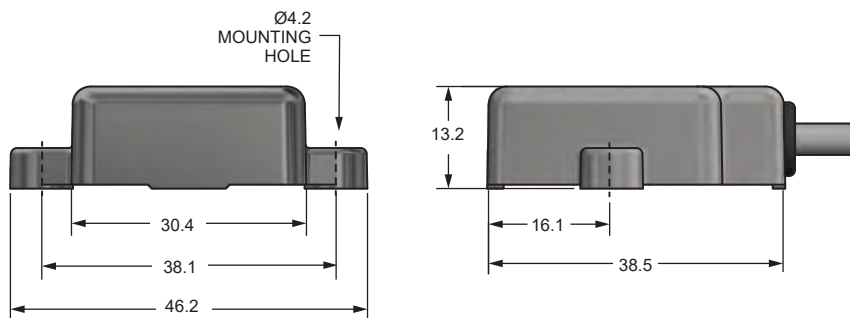

CONNECTION OPTIONS

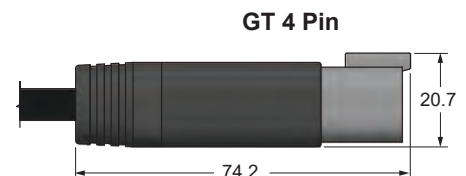
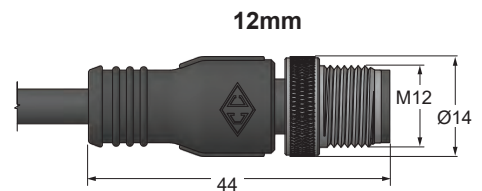
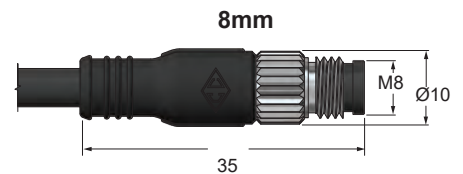

TECHNICAL DATA

Accuracy @ 20°C	-0.3° to +0.3°
Environmental Protection	Up to IP 69K
Materials	Housing: Zinc die-cast Housing Finish: Black powder coat
Number of Axis	Dual: 2
Angle Range	Both Axis -90° to +90°
Supply Current	30 mA Maximum
CAN Speed	250 kbps (default)
Startup Time	V _{cc} = 0V to V _{CC} = 12V 1 sec.
Resolution	0.01°
Update Rate	100 Hz
Supply Voltage	8 to 30V
Temperature Drift	+/- 1° Maximum
Temperature Range	-40° to +85°C
Cable Type	PVC (PUR on request. Consult Factory)
Wire Gauge	24 AWG

MOUNTING / SENSING ORIENTATION

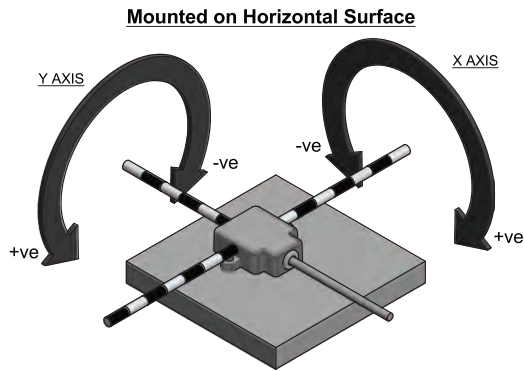

(ADDITIONAL) MATING CORDSETS / PIN CONFIGURATION

8mm female molded locking connector

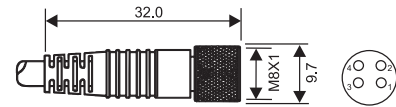

Brown = Pin 1
White = Pin 2
Blue = Pin 3
Black = Pin 4

Order P/N:
RC08-AFM040-0120C10A (2m length)
RC08-AFM040-0150C10A (5m length)

12mm female molded locking connector

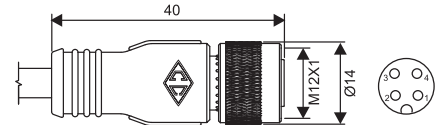

Brown = Pin 1
White = Pin 2
Blue = Pin 3
Black = Pin 4

Order P/N:
RC12-AFM040-0120C10A (2m length)
RC12-AFM040-0150C10A (5m length)

GT Deutsch style locking plug

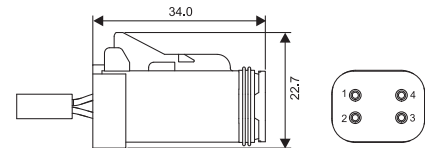

Brown = Pin 1
Blue = Pin 2
Black = Pin 3
Green = Pin 4

Order P/N:
GT0604-U000-1A (2m length)
GT0604-X000-1A (5m length)

ORDERING INFORMATION

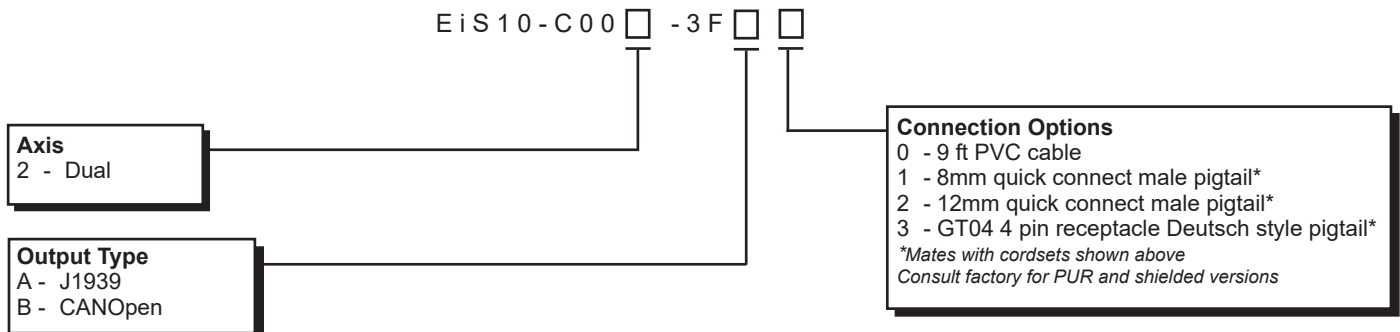

Ordering Example: EiS10-C002-3FA0

Dual Axis, J1939, 9 ft. PVC cable.

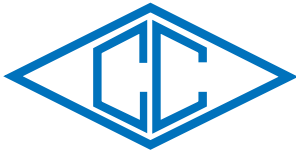

canfield
connector



ETS SERIES
ELECTRONIC
TILT
SWITCH

GENERAL DESCRIPTION

The Canfield Connector Electronic Tilt Switch is a rugged, non-mercury, all electronic sensor designed to trigger a precision output based on user defined angles of slope, tilt, or elevation of an object with respect to gravity, based on an artificial horizon. The Canfield Connector ETS Series is an all solid-state MEMs device designed to measure tilt and facilitate either a high or low signal output, while internally calculating the data within 0.5 degrees accuracy up to a preset trigger point within +/- 85 degrees. The unit features a rugged metal housing and is epoxy encapsulated for vibration, dust and water resistance to IP69K. The ETS Series is omnidirectional and boasts a temperature drift of +/- 1° maximum with a temperature range of -40 to 85°C. The ETS Series is digitally and temperature compensated and precisely calibrated to remove non-linearity of the trip point. Applications for Tilt Switches such as the ETS Series include platform leveling, motion limit sensing, boom angle sensing, cameras, machine arm angle sensing as well as mobile security systems. The unit comes with PVC wire (PUR on request), 9ft. length with other lengths and quick connections available. The unit is installed in place by use of two 4.2mm holes.



DIMENSIONAL DATA

All dimensions are in millimeters unless otherwise noted.

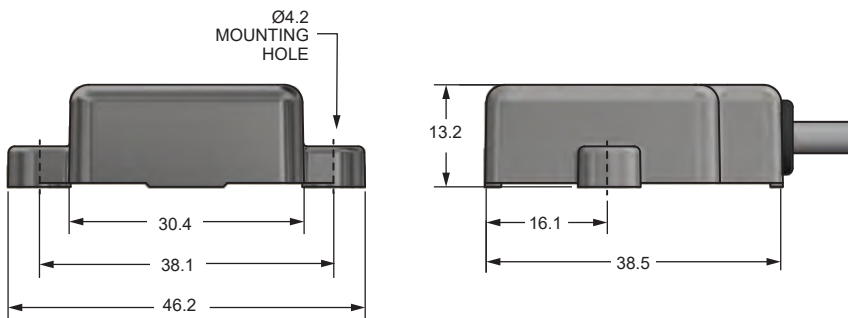

CONNECTION OPTIONS

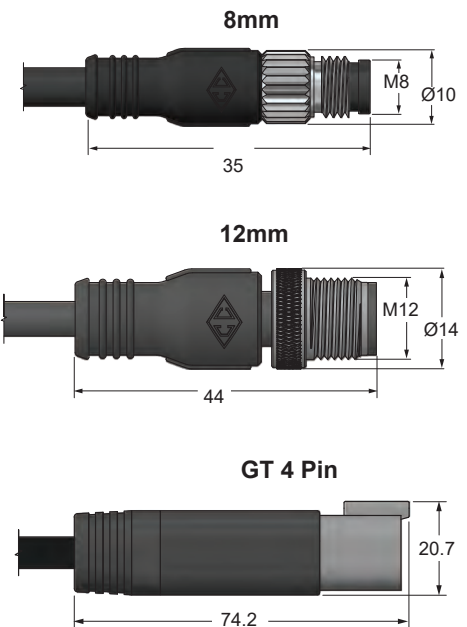

GRAPH

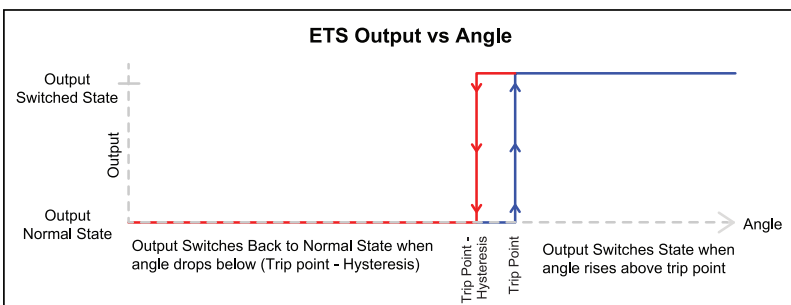

TECHNICAL DATA

Accuracy @ 20°C	0.5°
Environmental Protection	Up to IP 69K
Materials	Housing: Zinc die-cast Housing Finish: Black powder coat
Number of Axis	Single: 1 Dual: 2
Output Current	1Amp Max (each)
Output Format	Sourcing
Output Type	Supply 1V Max
Supply Voltage	12-24 VDC
Temperature Drift	+/- 1° Maximum
Temperature Range	-40° to +85°C
Cable Type	PVC (PUR on request. Consult Factory)
Wire Gauge	24 AWG

MOUNTING / SENSING ORIENTATION

Mounted on Horizontal Surface

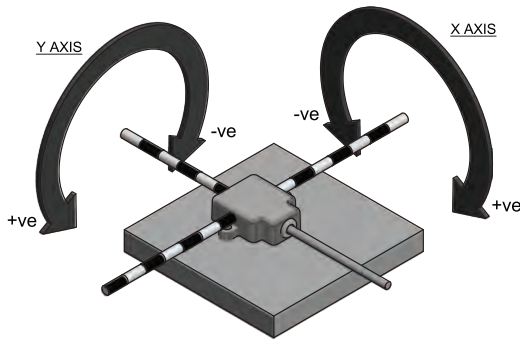

(ADDITIONAL) MATING CORDSETS / PIN CONFIGURATION

8mm female molded locking connector

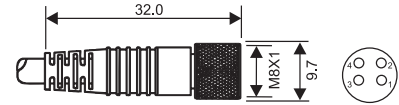

Brown = Pin 1
White = Pin 2
Blue = Pin 3
Black = Pin 4

Order P/N:

RC08-AFM040-0120C10A (2m length)
RC08-AFM040-0150C10A (5m length)

12mm female molded locking connector

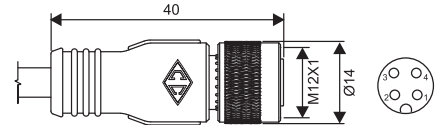

Brown = Pin 1
White = Pin 2
Blue = Pin 3
Black = Pin 4

Order P/N:

RC12-AFM040-0120C10A (2m length)
RC12-AFM040-0150C10A (5m length)

GT Deutsch style locking plug

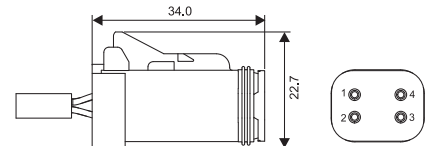

Brown = Pin 1
Blue = Pin 2
Black = Pin 3
Green = Pin 4

Order P/N:

GT0604-U000-1A (2m length)
GT0604-X000-1A (5m length)

ORDERING INFORMATION

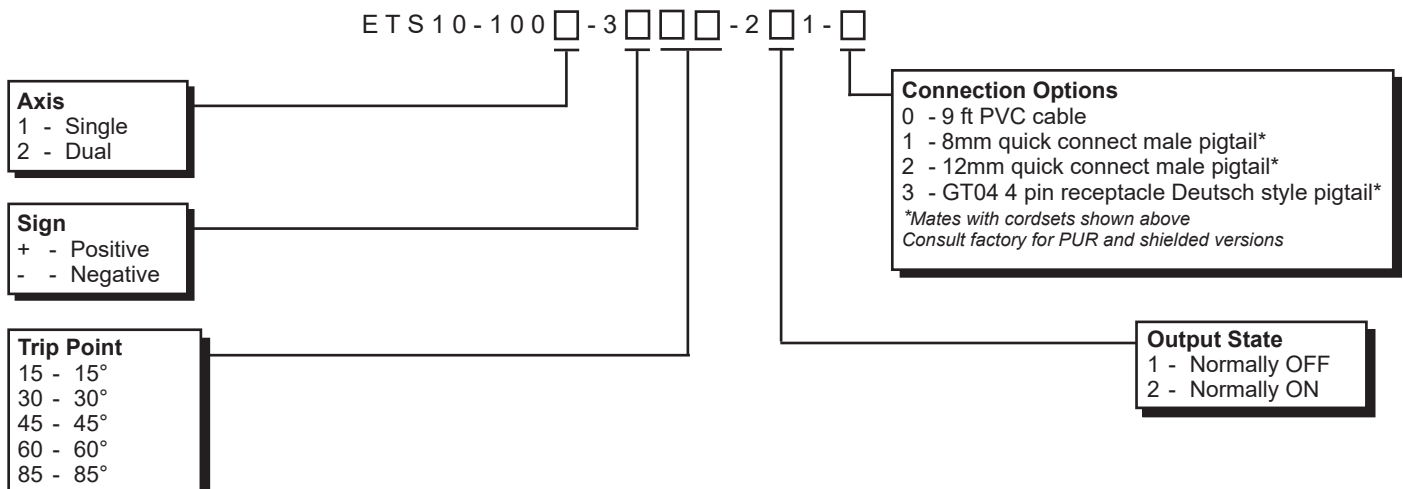

Ordering Example: ETS10-1001-3+15-211-0

Single Axis, +15° Trip Point, Normally Off, 9 ft. PVC cable.

GLOSSARY OF TERMS

AC - Acronym for Alternating Current.

AMP (A) - Abbreviation of Ampere, a unit of measure for electrical current

AWG - American Wire Gage is a numerical standard used to refer to the diameter Wire Gaugeal area of a wire. Smaller numbers refer to larger Wire Gaugeal areas.

Bridge Rectifier - This is an electrical device made up of four diodes, which perform the function of full wave rectification (converts the full AC sine wave to DC).

Capacitor - This is an electronic device used to store an electric charge or to allow varying current to flow. The ideal capacitor will not allow steady state or DC current to flow. The capacitor is used in many applications including transient suppression, electrical noise filtering, timing circuits, etc.

Conductor - This is a material that can easily conduct (flow) electrical current. Metals are considered to be good conductors of electricity.

Current Surge - This is a short term (transient) condition causing a larger than normal amount of current to flow through a conductor. A current surge can often cause damage to an electrical device that is not properly protected.

DC - Acronym for Direct Current.

DIN - This is an acronym used for the Deutsches Institut fur Normung (German Standardization Institute).

DIN 43650 - A German standard stating the characteristics and requirements of connectors for magnetic valves used in hydraulics and pneumatics.

Diode - This is a solid state electronic component that allows current to flow in only one direction, similar to a check valve used in hydraulic or pneumatic applications. The diode is used in applications including transient suppression, power supply circuits etc.

Electronic Magnetic Sensor - This is a solid state device used to sense a magnetic field. Canfield Connector uses magneto-resistive sensors on all electronic magnetic sensors.

Gauss (Ga) - Unit of measure for magnetic flux density.

Ground - This term is used to define an electrical connection normally common to the chassis of a device or earth ground.

Hertz (Hz) - The unit of measure for frequency in cycles per second.

IP65 - An environmental protection rating of enclosures according to the German Standard DIN 40050.

ISO - This is an acronym used for the International Standards Organization.

LED - An acronym for Light Emitting Diode. A solid state diode which emits light when current passes through it in the proper direction.

MOV - An acronym for Metal Oxide Varistor. A solid state device used to suppress voltage surges/spikes.

NEMA - An acronym for National Electric Manufacturers As-sociation.

Nitrile (Buna) - This is a rubber-like man-made material used extensively in gasket and sealing applications.

Normally Closed - The state of the output or switch is ON with no external influence.

Normally Open - The state of the output or switch is OFF with no external influence.

NPN (Sinking) - Acronym used to describe the polarization of bipolar junction transistors (BJTs). Also associated with a sinking output.

Opto-Coupled - Refers to a technique used to optically activate (turn on) an electronic device, usually a transistor or triac, and physically separate two sides of a circuit. This action is similar to a solenoid relay. The typical opto-coupler incorporates an LED (light emitting diode) as the actuating device.

Parallel Magnet Polarity - The term used to describe the polar orientation of the piston magnet with respect to the cylinder stroke. In this case, the north and south poles are oriented in the same direction parallel to the cylinder stroke.

Perpendicular Magnet Polarity - The term used to describe the polar orientation of the piston magnet with respect to the cylinder stroke. In this case, the north and south poles are oriented perpendicular to the cylinder stroke.

PNP (Sourcing) - Acronym used to describe the polarization of bipolar junction transistors (BJTs). Also associated with a sourcing output.

Rectification - This is a term used to describe an electrical process which converts AC (alternating current) to DC (direct current).

Reed Switch - This is a miniature mechanical switch that changes state when a magnetic field is applied.

Resistor - This is an electronic device that resists the flow of current. Higher resistor Ohm values offer more resistance to the flow of current.

Silicone - This is a rubber-like man-made material used extensively in gasket and sealing applications. It is very resistant to a wide range of chemicals including oils and solvents, and has a very wide temperature range.

Sinking - The term is used here to describe the way a switch is connected in the circuit. If the switch completes the electrical circuit by connecting the load to ground/(-), it is considered to be sinking the load. In a solid state device this is equivalent to a NPN output.

Solid State - This is a term often used to describe an electronic device made up of solid components (no moving parts).

Sourcing - The term is used here to describe the way a switch is connected in the circuit. If the switch completes the electrical circuit by connecting the load to the positive/(+), it is considered to be sourcing the load. In a solid state device this is equivalent to a PNP output.

SPST - Acronym used for Single Pole Single Throw switches.

SPDT - Acronym used for Single Pole Double Throw switches.

Transistor - This is a solid state device used in electronic circuits. It is often used in switching or amplifier applications.

Triac - This is a solid state device often used to switch AC voltage/ current.

Volt (V) - The unit of measure for electrical potential.

Voltage Spike - This is a short term (transient) condition causing a larger than normal amount of voltage to be applied to a circuit. Voltage spikes can often cause damage to an electric device that is not properly protected.

Watt (W) - The unit of measure for electrical power.

We appreciate your business!

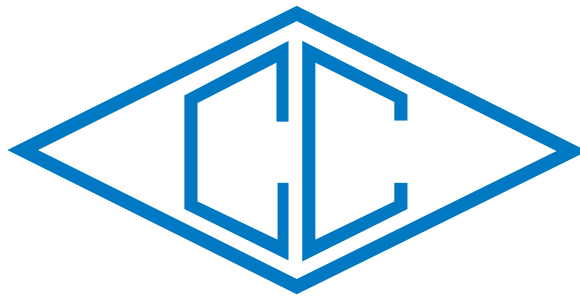

canfield connector

8510 Foxwood Court ♦ Youngstown, OH 44514

1-800-554-5071

Ph:(330)758-8299 ♦ Fx:(330)758-8912

www.canfieldconnector.com

