



# Cylinder Mounting Accessories

Catalog HY08-SB1300-1/NA

aerospace  
climate control  
electromechanical  
filtration  
fluid & gas handling  
hydraulics  
pneumatics  
process control  
sealing & shielding



ENGINEERING YOUR SUCCESS.

[www.mfcp.com](http://www.mfcp.com)

Schrader Bellows offers a complete selection of cylinder mounting accessories.

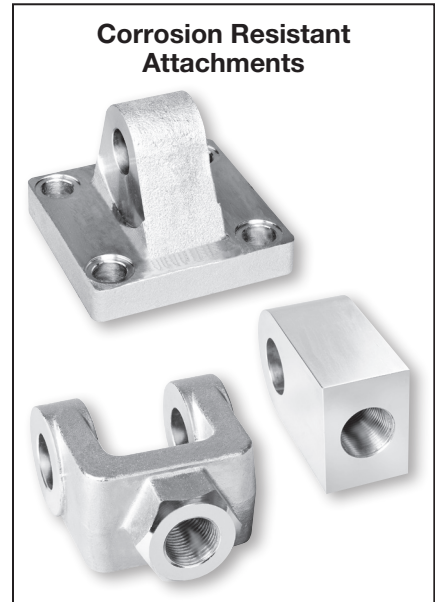
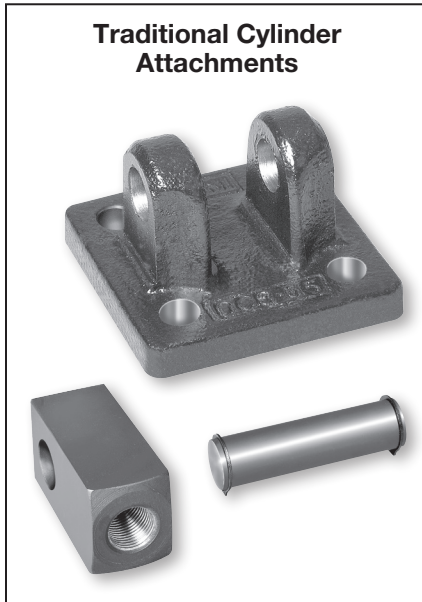

In line with our policy of continuing product improvement, specifications and information contained in this catalog are subject to change.

Copyright ©2019 by Parker Hannifin Corporation.  
 All rights reserved.

PRINTED IN THE U.S.A.

**⚠ WARNING**

**FAILURE OR IMPROPER SELECTION OR IMPROPER USE OF THE PRODUCTS AND/OR SYSTEMS DESCRIBED HEREIN OR RELATED ITEMS CAN CAUSE DEATH, PERSONAL INJURY AND PROPERTY DAMAGE.**

This document and other information from the Parker Hannifin Corporation, its subsidiaries and authorized distributors provide product and/or system options for further investigation by users having expertise. It is important that you analyze all aspects of your application, including consequences of any failure and review the information concerning the product or system in the current product catalog. Due to the variety of operating conditions and applications for these products or systems, the user, through its own analysis and testing, is solely responsible for making the final selection of the products and systems and assuring that all performance, safety and warning requirements of the application are met.

The products described herein, including without limitation, product features, specifications, designs, availability and pricing, are subject to change by Parker Hannifin Corporation and its subsidiaries at any time without notice.

**Offer of Sale**

The items described in this document are hereby offered for sale by Parker Hannifin Corporation, its subsidiaries or its authorized distributors. This offer and its acceptance are governed by provisions stated on a separate page of the document entitled 'Offer of Sale'.

**Table of Contents**

Rod Clevis / Eye Bracket / Pivot Pin	2-3
Knuckle / Clevis Bracket / Pivot Pin	4-5
Dual Axis Knuckle	6
Linear Alignment Couplers	7
Spherical Bearing Mount Accessories	8
Style SE Spherical Bearing Mount Accessories	9
Split Couplers & Weld Plates	10
Metric Rod Clevis / Eye Bracket / Pivot Pin	11
Metric Plain Rod Eye / Clevis Bracket / Pivot Pin	12
Metric Spherical Rod Eye / Clevis Bracket / Pivot Pin	13
Stainless Steel Accessories	14-16
Manufacturing Locations	17
Safety Guide	18-19
Offer of Sale	20

**New Cast Iron Clevis Brackets and Eye Brackets**

**With Higher Load Ratings than Traditional Fabricated Steel Construction!**

Cast iron Eye Bracket and Clevis Bracket mounting accessories have load ratings that meet or exceed the maximum force generated by heavy duty industrial hydraulic cylinders. They are available to complement our traditional steel accessories for NFPA cylinders.

**Forged Steel or Cast Ductile Iron  
Clevis Bracket**

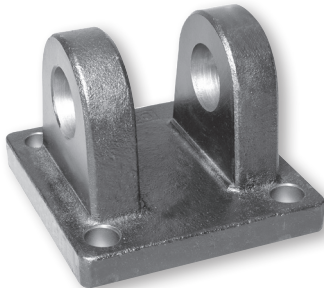

**Fabricated Steel Clevis Bracket**

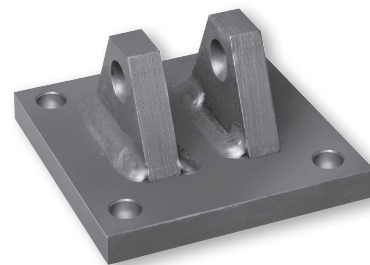

Consider the following when choosing between Forged Steel or Cast Ductile Iron and Fabricated Steel accessory brackets.

Eye Bracket / Clevis Bracket Feature	Material	
	Forged Steel or Cast Ductile Iron	Fabricated Steel
Load Rating	Meets or exceeds maximum force generated by heavy duty industrial hydraulic cylinders!	Unchanged from previous catalogs. Lower than cast iron in most sizes.
	See part number pages for details	
Mounting Method	Attach with threaded fasteners - Forged Steel may be welded	Attach with threaded fasteners or weld to machine
Dual Axis Knuckle Compatibility	Recommended - Allows maximum swing arc	Not recommended - Reduced swing arc
Value	Best economy with higher load ratings and high volume production	Good economy with weld-in-place mounting
Standardized Mounting	ANSI/(NFPA) T3.6.8 R3-2010	ANSI/(NFPA) T3.6.8 R1-1984

**Rod End Accessories**

Accessories offered for the rod end of the cylinder include: Rod Clevis, Eye Bracket, Knuckle, Clevis Bracket and Pivot Pin. To select the proper part number for any desired rod mounted accessory, refer to the table below and look opposite the thread size of the rod end as indicated in the first column. The Pivot Pins, Eye Brackets and Clevis Brackets are listed opposite the pin diameter that fits their mating Knuckles or Clevises.

**Accessory Load Capacity**

The various accessories on this and the following pages have been load rated for your convenience. The load capacity, shown in the table below, is the recommended maximum load for that accessory based on a 4:1 design factor in tension. (Pivot Pin is rated in shear.) Before specifying, compare the actual load or the tension (pull) force at maximum operating pressure of the cylinder with the load capacity of the accessory you plan to use. If load or pull force of cylinder exceeds load capacity of accessory, consult factory.

Thread Size	Pin Ø	Rod Clevis		Mounting Plate or Eye Bracket		Pivot Pin	
		Part Number	Load Capacity (lb)	Forged Steel or Cast Ductile Iron		Part Number	Shear Capacity (lb)
				Part Number	Load Capacity (lb)		
5/16-24	0.312	0512210000 <sup>1</sup>	2600	0959810031	1850	-	-
7/16-20	0.500	0509400000	4250	0959810050 <sup>2</sup>	4620	0683680000	8600
1/2-20	0.500	0509410000	4900	0959810050 <sup>2</sup>	4620	0683680000	8600
3/4-16	0.750	0509420000	11200	0959810075 <sup>2</sup>	12370	0683690000	19300
3/4-16	0.750	1332840000	11200	0959810075 <sup>2</sup>	12370	0683690000	19300
7/8-14	1.000	0509430000	18800	0959810100 <sup>2</sup>	20450	0683700000	34300
1-14	1.000	0509440000	19500	0959810100 <sup>2</sup>	20450	0683700000	34300
1-14	1.000	1332850000	19500	0959810100 <sup>2</sup>	20450	0683700000	34300
1 1/4-12	1.375	0509450000	33500	0959810138	33500	0683710000	65000
1 1/4-12	1.375	1332860000	33500	0959810138	33500	0683710000	65000
1 1/2-12	1.750	0509460000	45600	0959810175	49480	0683720000	105200
1 3/4-12	2.000	0509470000	65600	0959810200 <sup>2</sup>	70100	0683730000	137400
1 7/8-12	2.000	0509480000	65600	0959810200 <sup>2</sup>	70100	0683730000	137400
2 1/4-12	2.500	0509490000	98200	0959810250 <sup>2</sup>	98200	0683740000	214700
2 1/2-12	3.000	0509500000	98200	0959810300 <sup>2</sup>	121940	0683750000	309200
2 3/4-12	3.000	0509510000	98200	0959810300 <sup>2</sup>	121940	0683750000	309200
3 1/4-12	3.500	0509520000	156700	0959810350	187910	0735450000	420900
3 1/2-12	4.000	0509530000	193200	0959810400	268000	0735470000	565800
4-12	4.000	0509540000	221200	0959810400	268000	0735470000	565800

<sup>1</sup> Includes pivot pin.

<sup>2</sup> Cylinder accessory dimensions conform to ANSI/NFPA/T3.6.8 R3-2010.

**Forged Steel or Cast Ductile Iron Mounting Plate or Eye Bracket Dimensions<sup>3</sup>**

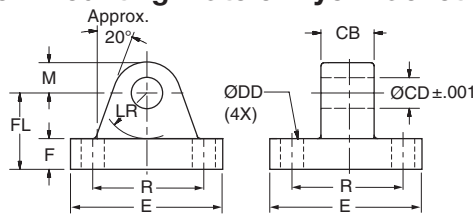

**Note: Cast ductile iron eye brackets must not be welded in place.**

Cast or Forged <sup>5</sup> Part Number	Pin Ø	CB	CD Ø	DD Ø	E (As Cast)	F	FL	LR	M (As Cast)	R
0959810031	0.312	0.31	0.314	0.27	2.25	0.38	1.00	0.59	0.38	1.75
0959810050	0.500	0.75	0.503	0.41	2.50	0.38	1.13	0.69	0.50	1.63
0959810075	0.750	1.25	0.753	0.53	3.50	0.63	1.88	1.13	0.75	2.55
0959810100	1.000	1.50	1.003	0.66	4.50	0.88	2.38	1.37	1.00	3.25
0959810138	1.375	2.00	1.378	0.66	5.00	1.00 <sup>4</sup>	3.00	1.88	1.38	3.82
0959810175	1.750	2.50	1.753	0.91	6.50	1.25 <sup>4</sup>	3.38	2.13	1.75	4.95
0959810200	2.000	2.50	2.003	1.06	7.50	1.50	4.00	2.38	2.00	5.73
0959810250	2.500	3.00	2.503	1.19	8.50	1.75	4.75	2.88	2.50	6.58
0959810300	3.000	3.00	3.003	1.31	9.50	2.00	5.25	3.13	3.00	7.50
0959810350	3.500	4.00	3.503	1.81	12.63	2.50 <sup>6</sup>	6.50 <sup>6</sup>	3.88	3.50	9.62
0959810400	4.000	4.50	4.003	2.06	14.88	3.00 <sup>6</sup>	7.50 <sup>6</sup>	4.38	4.06	11.45

<sup>3</sup> When used to mate with the Rod Clevis, select by pin diameter in the table above.

<sup>4</sup> These dimensions vary from NFPA standard. F is increased by 0.13. Sufficient LR clearance remains for full swing arc with Schrader Bellows cap clevis cylinders and rod clevises.

<sup>5</sup> Eye Brackets with pin diameters 0.500 thru 1.375 are forged steel. Eye Brackets with 0.312 and 1.750 pin diameter and larger are cast ductile iron.

<sup>6</sup> Mounting base thickness dimension F is increased on these sizes to provide greater load capacity than the former fabricated steel design. Cast ductile iron dimensions F and FL are 0.81 larger for 3.500 pin diameter and 1.06 larger for 4.000 pin diameter.

**Rod Clevis Dimensions**

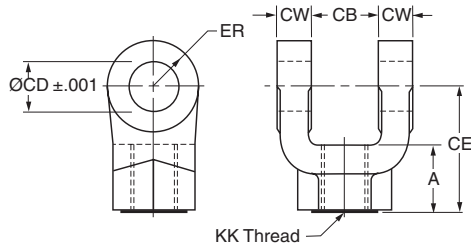

**Pivot Pin Dimensions**

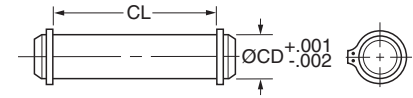

Part Number <sup>1</sup>	Pin Ø	A	CB	CD Ø	CE	CW	ER	KK Thread
0512210000 <sup>2</sup>	0.310	0.81	0.34	0.314	2.25	0.20	0.30	5/16-24
0509400000	0.500	0.75	0.77	0.503	1.50	0.49	0.50	7/16-20
0509410000	0.500	0.75	0.77	0.503	1.50	0.49	0.50	1/2-20
0509420000	0.750	1.13	1.27	0.753	2.13	0.62	0.75	3/4-16
1332840000	0.750	1.13	1.27	0.753	2.38	0.62	0.75	3/4-16
0509430000	1.000	1.63	1.52	1.003	2.94	0.74	1.00	7/8-14
0509440000	1.000	1.63	1.52	1.003	2.94	0.74	1.00	1-14
1332850000	1.000	1.63	1.52	1.003	3.13	0.74	1.00	1-14
0509450000	1.375	1.88	2.04	1.378	3.75	0.99	1.38	1 1/4-12
1332860000	1.375	2.00	2.04	1.378	4.13	0.99	1.38	1 1/4-12
0509460000	1.750	2.25	2.54	1.753	4.50	1.24	1.75	1 1/2-12
0509470000	2.000	3.00	2.54	2.003	5.50	1.24	2.00	1 3/4-12
0509480000	2.000	3.00	2.54	2.003	5.50	1.24	2.00	1 7/8-12
0509490000	2.500	3.50	3.04	2.503	6.50	1.49	2.50	2 1/4-12
0509500000	3.000	3.50	3.04	3.003	6.75	1.49	2.75	2 1/2-12
0509510000	3.000	3.50	3.04	3.003	6.75	1.49	2.75	2 3/4-12
0509520000	3.500	3.50 <sup>3</sup>	4.04	3.503	7.75	1.98	3.50	3 1/4-12
0509530000	4.000	4.00 <sup>3</sup>	4.54	4.003	8.81	2.23	4.00	3 1/2-12
0509540000	4.000	4.00 <sup>3</sup>	4.54	4.003	8.81	2.23	4.00	4-12

Part Number	CD Ø	CL
0683680000	0.500	1.88
0683690000	0.750	2.63
0683700000	1.000	3.13
0683710000	1.375	4.19
0683720000	1.750	5.19
0683730000	2.000	5.19
0683740000	2.500	6.19
0683750000	3.000	6.25
0735450000	3.500	8.25
0735470000 <sup>4</sup>	4.000	9.00

<sup>4</sup> This size supplied with cotter pins.

1. Pivot Pins are furnished with Clevis Mounted Cylinders as standard.
2. Pivot Pins are furnished with (2) Retainer Rings.
3. Pivot Pins must be ordered as a separate item if to be used with Knuckles, Rod Clevises, or Clevis Brackets.

<sup>1</sup> Rod Clevis' with pin diameters 0.312 thru 1.375 are forged steel. Rod Clevis' with 1.750 pin diameter and larger are cast ductile iron.

<sup>2</sup> Includes Pivot Pin

<sup>3</sup> Consult appropriate cylinder rod end dimensions for compatibility.

**Rod End Accessories**

Accessories offered for the rod end of the cylinder include Rod Clevis, Eye Bracket, Knuckle, Clevis Bracket, and Pivot Pin. To select the proper part number for any rod mounted accessory, refer to the table below and look in the row to the right of the rod thread in the first column. The Pivot Pins, Eye Brackets and Clevis Brackets are listed opposite the pin diameter that fits their mating Knuckles or Clevises.

**Accessory Load Capacity**

The various accessories have been load rated for your convenience. The load capacity, shown in the table below, is the recommended maximum load for that accessory based on a 4:1 design factor in tension. (Pivot Pin is rated in shear.) Before specifying, compare the actual load or the tension (pull) force at the maximum operating pressure of the cylinder with the load capacity of the accessory you plan to use. If load or pull force of cylinder exceeds load capacity of accessory, consult factory.

Thread Size	Pin Ø	Knuckle		Clevis Bracket				Pivot Pin	
		Part Number	Load Capacity (lb)	Forged Steel or Cast Ductile Iron		Fabricated Steel		Part Number	Shear Capacity (lb)
				Part Number	Load Capacity (lb)	Part Number	Load Capacity (lb)		
5/16-24	0.438	0740750000	3300	0960160044	2830	0740760000	3600	0740780000	6600
7/16-20	0.500	0690890000	5000	0960160050	7740	0692050000	7300	0683680000	8600
1/2-20	0.500	0690900000	5700	0960160050	7740	0692050000	7300	0683680000	8600
3/4-16	0.750	0690910000	12100	0960160075	13600	0692060000	10880	0683690000	19300
7/8-14	1.000	0690920000	13000	0960160100	23000	0692070000	15180	0683700000	34300
1-14	1.000	0690930000	21700	0960160100	23000	0692070000	15180	0683700000	34300
1 1/4-12	1.375	0690940000	33500	0960160138	39500	0692080000	23560	0683710000	65000
1 1/2-12	1.750	0690950000	45000	0960160175	49480	0692090000	21520	0683720000	105200
1 3/4-12	2.000	0690960000	53500	0960160200	72400	0692100000	26000	0692150000	137400
1 7/8-12	2.000	0962160000	75000	0960160200	72400	0692100000	26000	0692150000	137400
2 1/4-12	2.500	0962170000	98700	0960160250	98700	0692110000	28710	0683740000	214700
2 1/2-12	3.000	0962180000	110000	0960160300	123300	0692120000	28190	0683750000	309200
2 3/4-12	3.000	0962190000	123300	N/A	N/A	0692130000	31390	0692160000	309200
3 1/4-12	3.500	0962200000	161300	0960160350	200400	0735420000	80250	0735450000	420900
3 1/2-12	3.500	0962210000	217300	0960160350	200400	0735420000	80250	0735450000	420900
4-12	4.000	0962220000	273800	0960160400	292100	0735430000	98420	0821810000	565800
N/A	4.000	N/A	N/A	N/A	N/A	N/A	N/A	0735470000 <sup>1</sup>	565800

<sup>1</sup>This size supplied with cotter pins.

**Forged Steel or Cast Ductile Iron Clevis Bracket Dimensions**

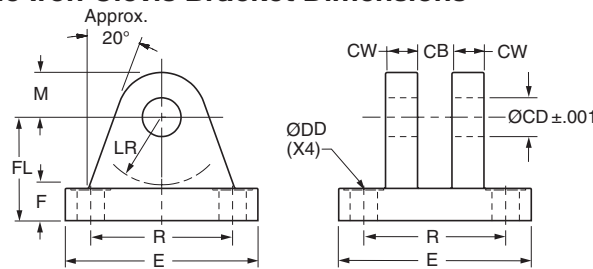

**Note: Cast ductile iron clevis brackets must not be welded in place.**

Cast or Forged <sup>2</sup> Part Number	Pin Ø	CB	CD Ø	CW	DD Ø	E (As Cast)	F	FL	LR	M (As Cast)	R
0960160044	0.438	0.46	0.440	0.37	0.27	2.25	0.38	1.00	0.56	0.44	1.75
0960160050	0.500	0.78	0.503	0.50	0.41	2.50	0.38	1.13	0.63	0.56	1.63
0960160075	0.750	1.28	0.753	0.63	0.53	3.50	0.63	1.88	1.06	0.75	2.56
0960160100	1.000	1.53	1.003	0.75	0.66	4.50	0.75	2.25	1.25	1.00	3.25
0960160138	1.375	2.03	1.378	1.00	0.66	5.00	0.88	3.00	1.94	1.38	3.81
0960160175	1.750	2.53	1.753	1.25	0.91	6.50	0.94	3.13	2.00	1.75	4.94
0960160200	2.000	2.53	2.003	1.25	1.06	7.50	1.38	3.75	2.25	2.00	5.75
0960160250	2.500	3.03	2.503	1.50	1.19	8.50	1.50	4.50	2.81	2.50	6.59
0960160300	3.000	3.03	3.003	1.50	1.31	9.50	1.88	5.38	3.31	3.00	7.50
0960160350	3.500	4.03	3.503	2.00	1.81	12.63	2.31	6.38	3.88	3.50	9.62
0960160400	4.000	4.53	4.003	2.25	2.06	14.88	2.88	7.50	4.50	4.00	11.50

<sup>2</sup> Clevis Brackets with pin diameters 0.500 thru 1.375 are forged steel. Clevis Brackets with 0.438 and 1.750 pin diameter and larger are cast ductile iron.

**Knuckle Dimensions**

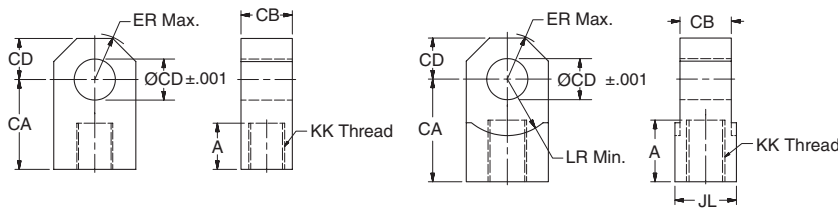

Thread Size thru 1 3/4-12

Thread Size 1 7/8-12 & Larger

Part Number	Pin Ø	A	CA	CB	CD Ø	ER	JL	LR min	KK Thread
0740750000	0.438	0.75	1.50	0.43	0.440	0.53	-	-	5/16-24
0690890000	0.500	0.75	1.50	0.75	0.503	0.59	-	-	7/16-20
0690900000	0.500	0.75	1.50	0.75	0.503	0.59	-	-	1/2-20
0690910000	0.750	1.13	2.06	1.25	0.753	0.87	-	-	3/4-16
0690920000	1.000	1.13	2.38	1.50	1.003	1.15	-	-	7/8-14
0690930000	1.000	1.63	2.81	1.50	1.003	1.15	-	-	1-14
0690940000	1.375	2.00	3.44	2.00	1.378	1.55	-	-	1 1/4-12
0690950000	1.750	2.25	4.00	2.50	1.753	1.96	-	-	1 1/2-12
0690960000	2.000	2.25	4.38	2.50	2.003	2.24	-	-	1 3/4-12
0962160000	2.000	3.00	5.00	2.50	2.003	2.24	3.00	2.77	1 7/8-12
0962170000	2.500	3.50	5.81	3.00	2.503	2.76	3.50	3.09	2 1/4-12
0962180000	3.000	3.50	6.13	3.00	3.003	3.30	4.00	3.58	2 1/2-12
0962190000	3.000	3.63	6.50	3.50	3.003	3.30	4.00	3.58	2 3/4-12
0962200000	3.500	4.50	7.63	4.00	3.503	3.87	6.00	4.18	3 1/4-12
0962210000	3.500	5.00	7.63	4.00	3.503	3.87	6.00	4.18	3 1/2-12
0962220000	4.000	5.50	9.13	4.50	4.003	4.43	6.00	4.80	4-12

**Pivot Pin Dimensions**

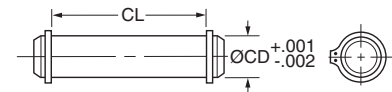

Part Number	CD Ø	CL
0740780000	0.438	1.31
0683680000	0.500	1.88
0683690000	0.750	2.63
0683700000	1.000	3.13
0683710000	1.375	4.19
0683720000	1.750	5.19
0692150000	2.000	5.69
0683740000	2.500	6.19
0683750000	3.000	6.25
0692160000	3.000	6.75
0735450000	3.500	8.25
0821810000	4.000	8.69
0735470000 <sup>1</sup>	4.000	9.00

<sup>1</sup>This size supplied with cotter pins.

1. Pivot Pins are furnished with Clevis Mounted Cylinders as standard.
2. Pivot Pins are furnished with (2) Retainer Rings.
3. Pivot Pins must be ordered as a separate item if to be used with Knuckles, Rod Clevises, or Clevis Brackets.

**Fabricated Steel Clevis Bracket Dimensions**

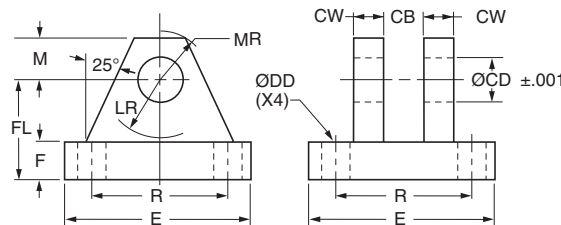

Fabricated Steel Part Number	Pin <sup>2</sup> Ø	CB	CD Ø	CW	DD Ø	E	F	FL	LR	M	MR	R
0692050000	0.500	0.80	0.503	0.50	0.41	3.50	0.50	1.50	0.75	0.50	0.63	2.55
0692060000	0.750	1.30	0.753	0.63	0.53	5.00	0.63	1.88	1.19	0.75	0.91	3.82
0692070000	1.000	1.59	1.003	0.75	0.66	6.50	0.75	2.25	1.50	1.00	1.25	4.95
0692080000	1.375	2.09	1.378	1.00	0.66	7.50	0.88	3.00	2.00	1.38	1.66	5.73
0692090000	1.750	2.59	1.753	1.25	0.91	9.50	0.88	3.63	2.75	1.75	2.22	7.50
0692100000	2.000	2.59	2.003	1.50	1.06	12.75	1.00	4.25	3.19	2.25	2.78	9.40
0692110000	2.500	3.09	2.503	1.50	1.19	12.75	1.00	4.50	3.50	2.50	3.13	9.40
0692120000	3.000	3.09	3.003	1.50	1.31	12.75	1.00	6.00	4.25	3.00	3.59	9.40
0692130000	3.000	3.59	3.003	1.50	1.31	12.75	1.00	6.00	4.25	3.00	3.59	9.40
0735420000	3.500	4.09	3.503	2.00	1.81	15.50	1.69	6.69	5.00	3.50	4.13	12.00
0735430000	4.000	4.59	4.003	2.00	2.06	17.50	1.94	7.69	5.75	4.00	4.88	13.75

<sup>2</sup> Clevis Bracket for 0.438 diameter pin is only available in cast ductile iron construction. See part number 0960160044 on previous page.

**Dual Axis Knuckle**

Using a Dual Axis Knuckle permits increased angular movement from the cylinder center line. Clevis or Eye mounted cylinders often require movement beyond the plane that two pivot pins allow. Spherical bearing mounts permit angular movement up to 4.5° within the pivoting plane. A Dual Axis Knuckle, with two pin holes 90° apart, installed at the cap and rod end of a cap fixed clevis mount (Style MP1) cylinder adds two pivot points, thereby providing up to 30° movement in another plane at each end.

**Dual Axis Knuckle Benefits**

- Increased angular movement range compared to spherical bearing mount.
- Significantly higher dynamic load rating than spherical bearing mount.
- Reduced bearing loads and wear that results from misalignment.
- Allows faster assembly of pivoting cylinders to the machine.

**Maximum Achievable Angular Movement from Cylinder Centerline\***

**Inboard Pin -**

15° maximum movement for cylinder misalignment only.

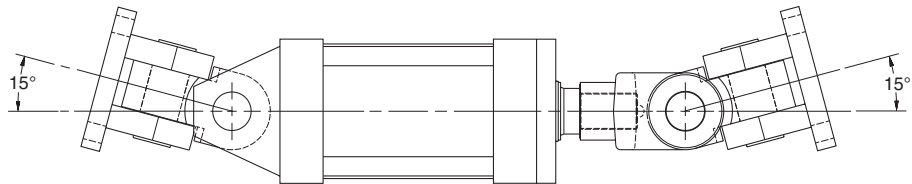

**Outboard Pin -**

30° maximum movement when applying force to a load moving in a curved plane.

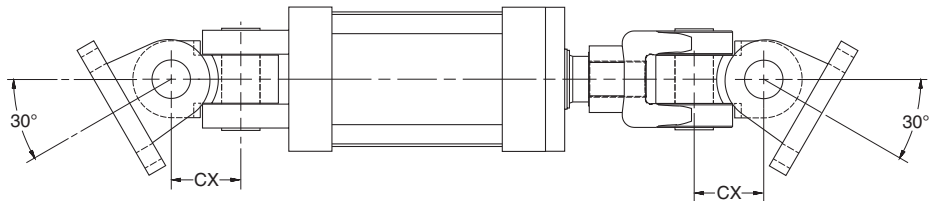

\*Maximum movement is achieved with cast clevis brackets. Movement is reduced when using fabricated clevis brackets.

**Dual Axis Knuckle Dimensions and Usage**

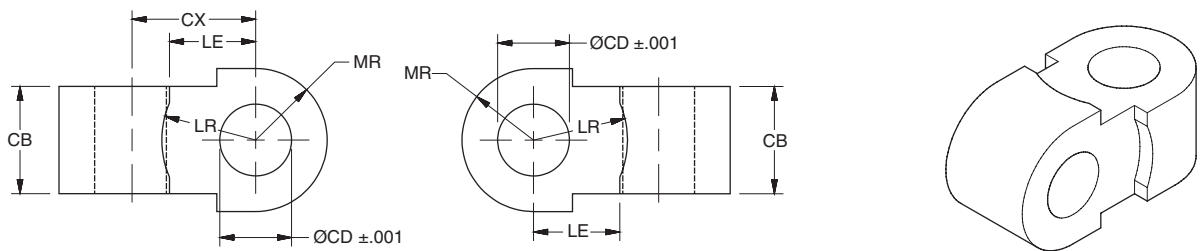

Part Number	Pin Ø	Load Capacity (lb)	CB	CD Ø	CX	LE	LR	MR	Mating Parts		Mounting Style MP1 Usage by Series & Bore	
									Clevis Bracket	Rod Clevis	PA-2 & PL-2	PH-2
0952670000	0.500	4380	0.75	0.503	0.88	0.54	0.63	0.50	0960160050	0509400000, 0509410000	1.50, 2.00, 2.50	1.50
0952680000	0.750	12370	1.25	0.753	1.19	0.80	0.94	0.75	0960160075	0509420000, 1332840000	3.25, 4.00, 5.00	2.00, 2.50
0952690000	1.000	20500	1.50	1.003	1.69	1.05	1.22	1.00	0960160100	0509430000, 0509440000, 1332850000	6.00, 7.00, 8.00	3.25
0952700000	1.375	30500	2.00	1.378	2.38	1.44	1.69	1.38	0960160138	0509450000, 1332860000	10.00	4.00
0952710000	1.750	49500	2.50	1.753	3.06	1.81	2.19	1.75	0960160175	0509460000	12.00	5.00
0952720000	2.000	68000	2.50	2.003	3.63	2.09	2.44	2.00	0960160200	0509470000, 0509480000	14.00	6.00



**Linear Alignment Couplers are available in 19 standard thread sizes...**

**Cost Saving Features and Benefits Include...**

- Maximum reliability for trouble-free operation, long life and lower operating costs
- Increased cylinder life by reducing wear on Piston and Rod bearings
- Simplifying Cylinder installation and reducing assembly costs
- Increase Rod Bearing and Rod Seal life for lower maintenance costs

**Alignment Coupler**

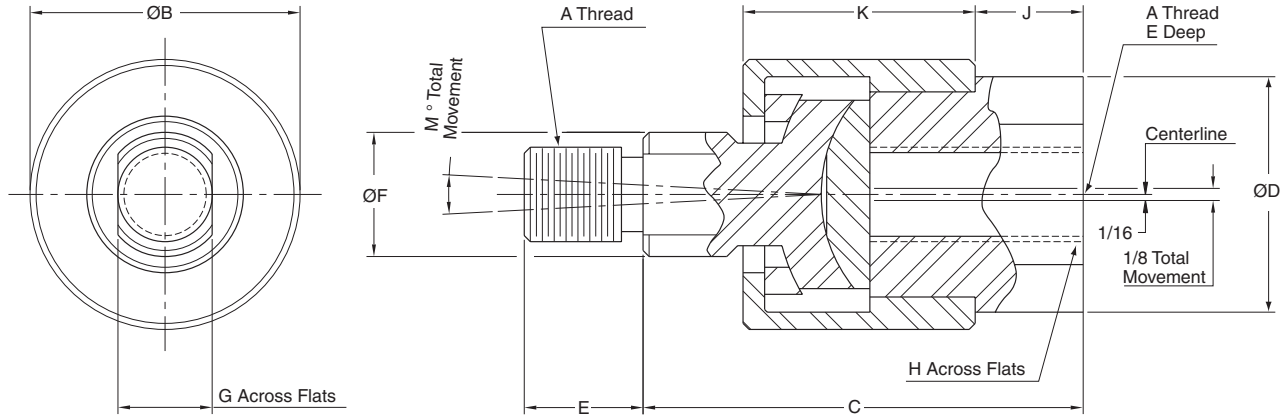

**Part Numbers and Dimensions**

Part No.	A <sup>1</sup> Thread	B Ø	C	D Ø	E	F Ø	G	H	J	K	M	Max. Pull Load (lb)	Max. Approx. Weight (lb)
1347570031	5/16-24	1.13	1.75	0.94	0.50	0.50	0.38	0.75	0.38	0.94	6°	1200	.35
1347570038	3/8-24	1.13	1.75	0.94	0.50	0.50	0.38	0.75	0.38	0.94	6°	2425	.35
1347570044	7/16-20	1.38	2.00	1.13	0.75	0.63	0.50	0.88	0.38	1.09	6°	3250	.55
1347570050	1/2-20	1.38	2.00	1.13	0.75	0.63	0.50	0.88	0.38	1.09	6°	4450	.55
1347570063	5/8-18	1.38	2.00	1.13	0.75	0.63	0.50	0.88	0.38	1.09	6°	6800	.55
1347570075	3/4-16	2.00	2.31	1.63	1.13	0.94	0.75	1.31	0.44	1.28	6°	9050	1.4
1347570088	7/8-14	2.00	2.31	1.63	1.13	0.94	0.75	1.31	0.44	1.28	6°	14450	1.4
1347570100	1-14	3.13	3.00	2.38	1.63	1.44	1.25	1.88	0.75	1.78	6°	19425	4.8
1347570125	1 1/4-12	3.13	3.00	2.38	1.63	1.44	1.25	1.88	0.75	1.78	6°	30500	4.8
1337390125	1 1/4-12	3.50	4.00	2.00	2.00	1.50	1.25	1.69	0.75	2.50	10°	30500	6.9
1337390150	1 1/2-12	4.00	4.38	2.25	2.25	1.75	1.50	1.94	0.88	2.75	10°	45750	9.8
1337390175	1 3/4-12	4.00	4.38	2.25	2.25	1.75	1.50	1.94	0.88	2.75	10°	58350	9.8
1337390188	1 7/8-12	5.00	5.63	3.00	3.00	2.25	2.00	2.63	1.38	3.38	10°	67550	19.8
1337390200	2-12	5.00	5.63	3.00	3.00	2.25	2.00	2.63	1.38	3.38	10°	77450	19.8
1337390225	2 1/4-12	6.75	6.38	3.25	3.50	2.75	2.38	2.88	1.63	3.75	10°	99250	35.3
1337390250	2 1/2-12	7.00	6.50	4.00	3.50	3.25	2.88	3.38	1.63	3.88	10°	123750	45.3
1337390275	2 3/4-12	7.00	6.50	4.00	3.50	3.25	2.88	3.38	1.63	3.88	10°	150950	45.3
1337390300	3-12	7.00	6.50	4.00	3.50	3.25	2.88	3.38	1.63	3.88	10°	180850	45.3
1337390325	3 1/4-12	9.25	8.50	5.25	4.50	4.00	3.38	4.50	2.00	5.50	10°	218450	-
1337390425	4 1/4-12	12.88	11.25	7.75	4.50	5.50	4.88	7.00	1.50	8.75	10°	370850	-

<sup>1</sup> metric thread also available - Contact the factory.

**How to Order Linear Alignment Couplers** – When ordering a cylinder with a threaded male rod end, specify the coupler of equal thread size by part number as listed in Table 1, i.e.; Piston Rod “KK” or “CC” dimension is 3/4” - 16”, specify coupler part number 1347570075.

Schrader Bellows offers a complete range of Cylinder Accessories to assure you of the greatest versatility in present or future cylinder applications. Accessories offered for spherical bearing mount cylinders include the Rod Eye,

Pivot Pin and Clevis Bracket. To select the proper part number for any desired accessory refer to the tables below.

**Spherical Rod Eye Dimensions**

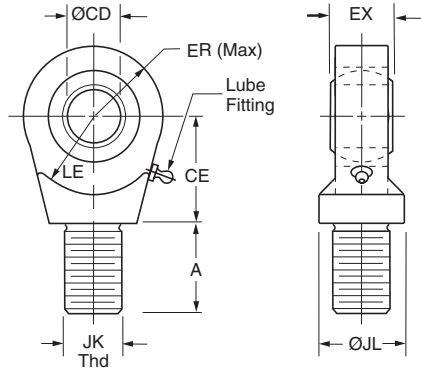

Bore Ø	Part No.	CD Ø	A	CE	EX	ER	LE	JK Thread	JL Ø	Load Capacity (lb)
1.50	0961000050	.5000 <sup>-0005</sup>	0.72	0.86	0.44	0.80	0.78	7/16-20	0.88	2644
2.00 & 2.50	0961000075	.7500 <sup>-0005</sup>	1.02	1.25	0.66	1.14	1.06	3/4-16	1.31	9441
3.25	0961000100	1.0000 <sup>-0005</sup>	1.52	1.88	0.88	1.34	1.45	1-14	1.50	16860
4.00	0961000138	1.3750 <sup>-0005</sup>	2.02	2.13	1.19	1.67	1.91	1 1/4-12	2.00	28562
5.00	0961000175	1.7500 <sup>-0005</sup>	2.14	2.50	1.53	2.05	2.16	1 1/2-12	2.00	43005
6.00	0961000200	2.0000 <sup>-0005</sup>	2.89	2.75	1.75	2.60	2.50	1 7/8-12	2.75	70193

Order to fit Piston Rod Thread Size.

**Pivot Pin Dimensions**

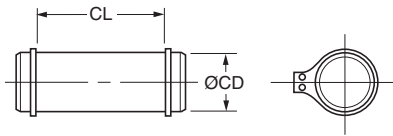

Bore Ø	Part No.	CD Ø	CL	Shear Capacity (lb)
1.50	0839620000	.4997 <sup>-0004</sup>	1.56	8600
2.00 & 2.50	0839630000	.7497 <sup>-0005</sup>	2.03	19300
3.25	0839640000	.9997 <sup>-0005</sup>	2.50	34300
4.00	0839650000	1.3746 <sup>-0006</sup>	3.31	65000
5.00	0839660000	1.7496 <sup>-0006</sup>	4.22	105200
6.00	0839670000	1.9996 <sup>-0007</sup>	4.94	137400

Pivot Pins are furnished with (2) Retainer Rings.

**Clevis Bracket Dimensions**

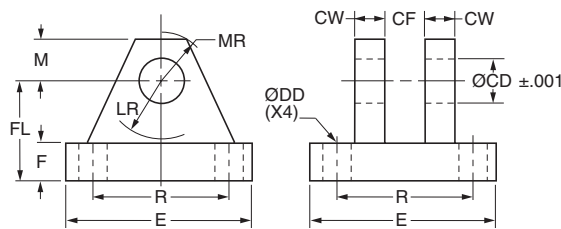

**Fabricated Steel**

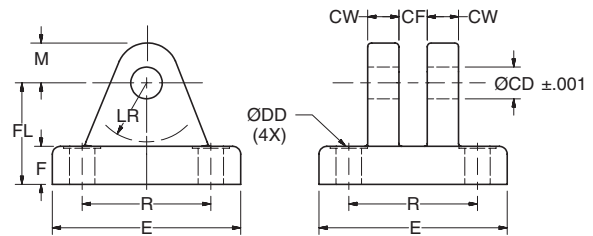

**Cast Ductile Iron**

Order to fit Cylinder Cap or Rod Eye.

Bore Ø	Pin Ø	Cast Ductile Iron Part Number	Fabricated Steel Part Number	CD Ø	CF	CW	DD Ø	E	F	FL	LR	M	MR	R	Load Capacity (lb)
1.50	0.500	0959450000	0839470000	0.503	0.45	0.50	0.41	3.00	0.50	1.50	0.94	0.50	0.63	2.05	5770
2.00 & 2.50	0.750	0959300000	0839480000	0.753	0.67	0.63	0.53	3.75	0.63	2.00	1.38	0.88	1.00	2.76	9450
3.25	1.000	0959310000	0839490000	1.003	0.89	0.75	0.53	5.50	0.75	2.50	1.69	1.00	1.19	4.10	14300
4.00	1.375	0959320000	0839500000	1.378	1.20	1.00	0.66	6.50	0.88	3.50	2.44	1.38	1.63	4.95	20322
5.00	1.750	0959330000	0839510000	1.753	1.55	1.25	0.91	8.50	1.25	4.50	2.88	1.75	2.06	6.58	37800
6.00	2.000	0959340000	0839520000	2.003	1.77	1.50	0.91	10.63	1.50	5.00	3.00	2.00	2.38	7.92	50375

Schrader Bellows offers a complete range of Cylinder Accessories to assure you of the greatest versatility in present or future cylinder applications. Accessories offered for spherical bearing mount cylinders include

the Rod Eye, Pivot Pin and Clevis Bracket. To select the proper part number for any desired accessory refer to the tables below.

**Spherical Rod Eye Dimensions**

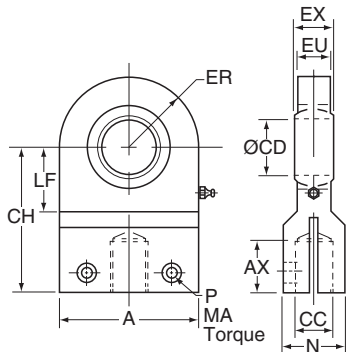

Bore Ø	Part Number	A	AX (min.)	CH	CD Ø	ER	EU	EX	CC Thread	LF	MA (lb-ft)	N	P (SHCS)	Load Cap. (lb)
1.50	0978200075	1.75	0.75	1.75	0.7500 <sup>-0.0004</sup>	0.88	0.56	0.656	1/2-20	0.94	11	0.88	1/4-28	5,301
2.00	0978200100	2.50	1.13	2.50	1.0000 <sup>-0.0004</sup>	1.25	0.75	0.875	7/8-14	1.19	40	1.25	3/8-24	9,425
2.50	0978200125	3.00	1.13	2.75	1.2500 <sup>-0.0005</sup>	1.50	0.94	1.093	7/8-14	1.44	40	1.38	3/8-24	14,726
3.25	0978200150	4.00	1.63	3.75	1.5000 <sup>-0.0005</sup>	2.00	1.13	1.312	1 1/4-12	1.75	100	2.00	1/2-20	24,887
4.00	0978200200	4.50	2.00	4.50	2.0000 <sup>-0.0005</sup>	2.25	1.50	1.750	1 1/2-12	2.25	185	2.50	5/8-18	37,699
5.00	0978200250	6.00	2.25	5.25	2.5000 <sup>-0.0005</sup>	3.00	1.88	2.187	1 3/4-12	2.81	325	2.75	3/4-16	58,905
6.00	0978200300	7.00	3.00	6.75	3.0000 <sup>-0.0005</sup>	3.50	2.25	2.625	2 1/4-12	3.31	525	3.50	7/8-14	84,823
7.00	0978200350	8.00	3.50	8.00	3.5000 <sup>-0.0005</sup>	4.00	2.63	3.062	2 3/4-12	3.94	800	4.50	1-14	115,454
8.00	0978200400	9.00	3.50	8.50	4.0000 <sup>-0.0005</sup>	4.50	3.00	3.500	3 1/4-12	4.50	800	5.00	1-14	150,796

Order to fit Piston Rod Thread Size.

**Pivot Pin Dimensions**

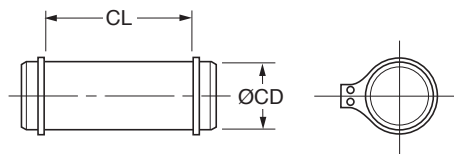

Pivot Pins are furnished with (2) Retainer Rings.

Bore Ø	Pin Ø	Part Number	CD Ø	CL	Shear Capacity (lb)
1.50	0.750	0977260075	0.7497 <sup>-0.0005</sup>	1.78	19,300
2.00	1.000	0977260100	0.9997 <sup>-0.0005</sup>	2.00	34,300
2.50	1.250	0977260125	1.2496 <sup>-0.0006</sup>	2.50	53,600
3.25	1.500	0977260150	1.4996 <sup>-0.0006</sup>	3.00	77,300
4.00	2.000	0977260200	1.9996 <sup>-0.0007</sup>	3.94	137,400
5.00	2.500	0977260250	2.4996 <sup>-0.0007</sup>	4.87	214,700
6.00	3.000	0977260300	2.9996 <sup>-0.0007</sup>	5.31	309,100
7.00	3.500	0977260350	3.4995 <sup>-0.0009</sup>	6.25	420,700
8.00	4.000	0977260400	3.9995 <sup>-0.0009</sup>	6.69	549,400

**Clevis Bracket Dimensions**

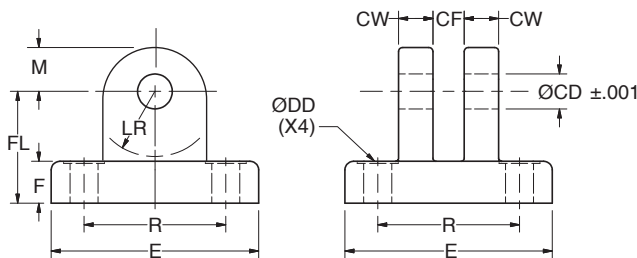

Order to fit Cylinder Cap or Rod Eye.

**Fabricated Steel**

Bore Ø	Pin Ø	Part Number	CD Ø ±0.001	CF	CW	DD Ø	E	F	FL	LR	M	R	Load Capacity (lb)
1.50	0.750	0977270075	0.753	0.67	0.50	0.41	2.75	0.38	1.63	1.06	0.63	2.00	5,301
2.00	1.000	0977270100	1.003	0.89	0.50	0.47	3.25	0.50	2.00	1.31	0.81	2.44	9,425
2.50	1.250	0977270125	1.253	1.11	0.63	0.53	4.00	0.75	2.50	1.56	1.00	3.00	14,726
3.25	1.500	0977270150	1.503	1.33	0.75	0.66	5.00	0.75	3.00	2.06	1.25	3.75	24,887
4.00	2.000	0977270200	2.003	1.77	1.00	0.66	5.50	1.00	3.50	2.31	1.63	4.31	37,699
5.00	2.500	0977270250	2.503	2.20	1.25	0.91	7.00	1.25	4.50	3.06	2.00	5.44	58,905
6.00	3.000	0977270300	3.003	2.64	1.25	1.06	8.25	1.50	5.25	3.56	2.50	6.38	84,823
7.00	3.500	0977270350	3.503	3.08	1.50	1.19	9.25	1.75	6.00	4.06	3.00	7.38	115,454
8.00	4.000	0977270400	4.003	3.52	1.50	1.31	10.50	2.00	6.75	4.56	3.50	8.50	150,796

**Schrader Bellows “Style 6” Piston Rod End**

Split Couplers and Weld Plates

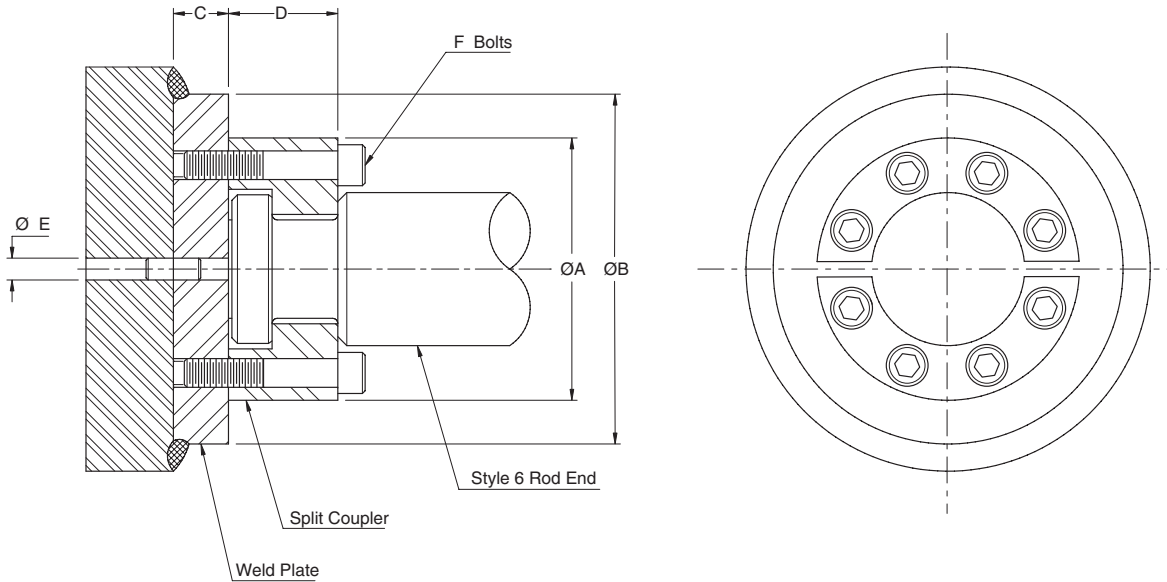

**⚠WARNING:** Piston rod separation from the machine member can result in severe personal injury or even death to nearby personnel. The cylinder user must make sure the weld holding the weld plate to the machine is of sufficient quality and size to hold the intended load. The cylinder user must also make sure the bolts holding split coupler to the weld plate are of sufficient strength to hold the intended load and installed in such a way that they will not become loose during the machine's operation.

**Part Numbers and Dimensions**

Rod Ø	A Ø	B Ø	C	D	E Ø	F	Bolt Size	Bolt Circle	Split Coupler Part No.	Weld Plate Part No.
0.625	1.50	2.00	.50	.56	.250	4	#10-24 x .94 LG	1.125	1472340062	1481740062
1.000	2.00	2.50	.50	.88	.250	6	.250-20 x 1.25 LG	1.500	1472340100	1481740100
1.375	2.50	3.00	.63	1.00	.250	6	.312-18 x 1.50 LG	2.000	1472340138	1481740138
1.750	3.00	4.00	.63	1.25	.250	8	.312-18 x 1.75 LG	2.375	1472340175	1481740175
2.000	3.50	4.00	.75	1.63	.375	12	.375-16 x 2.25 LG	2.687	1472340200	1481740200
2.500	4.00	4.50	.75	1.88	.375	12	.375-16 x 2.50 LG	3.187	1472340250	1481740250
3.000	5.00	5.50	1.00	2.38	.375	12	.500-13 x 3.25 LG	4.000	1472340300	1481740300
3.500	5.88	7.00	1.00	2.63	.375	12	.625-11 x 3.50 LG	4.687	1472340350	1481740350
4.000	6.38	7.00	1.00	2.63	.375	12	.625-11 x 3.50 LG	5.187	1472340400	1481740400
4.500	6.88	8.00	1.00	3.13	.375	12	.625-11 x 4.00 LG	5.687	1472340450	1481740450
5.000	7.38	8.00	1.00	3.13	.375	12	.625-11 x 4.00 LG	6.187	1472340500	1481740500
5.500	8.25	9.00	1.25	3.88	.375	12	.750-10 x 5.00 LG	6.875	1472340550	1481740550
7.000	10.38	11.00	1.75	4.00	.500	12	1.00-8 x 5.50 LG	8.750	1472340700	1481740700
8.000	11.38	12.00	2.00	4.00	.500	16	1.00-8 x 5.50 LG	9.750	1472340800	1481740800
8.500	12.38	13.00	2.00	4.00	.500	16	1.00-8 x 5.50 LG	10.750	1472340850	1481740850
9.000	13.12	14.00	2.25	4.00	.500	12	1.25-7 x 6.00 LG	11.125	1472340900	1481740900
10.000	14.12	15.00	2.50	4.47	.500	16	1.25-7 x 6.50 LG	12.125	1472341000	1481741000

Note: Bolts are not included with split coupler or weld plate.

**Metric Accessories**

**Cylinders**

**Cylinder Mounting Accessories**

**Accessory Selection**

Accessories for the rod end of a cylinder are selected by reference to the rod end thread, while the same accessories, when used at the cap end, are selected by cylinder bore size. See tables of part numbers below, and on the following pages.

**Rod and Cap End Accessories**

Accessories for the ISO 6020-2 cylinder include:

- Rod End** – rod clevis, eye bracket and pivot pin
  - plain rod eye, clevis bracket and pivot pin
  - rod eye with spherical bearing
- Cap End** – eye bracket for cap clevis mounting
  - clevis bracket for cap eye mounting
  - pivot pin for eye bracket and clevis bracket

**Rod Clevis, Eye Bracket and Pivot Pin**

KK Thread	Rod Clevis	Eye Bracket	Pivot Pin	Nominal Force kN	Weight kg
M10x1.25	1434470000	1448080000	1434770000	8	0.3
M12x1.25	1434480000	1448090000	1434780000	12.5	0.6
M14x1.5	1434490000	1448100000	1434790000	20	0.8
M16x1.5	1434500000	1448110000	1434800000	32	2.2
M20x1.5	1434510000	1448120000	1434800000	50	2.7
M27x2	1434520000	1448130000	1434810000	80	5.9
M33x2	1434530000	1448140000	1434820000	125	9.4
M42x2	1434540000	1448150000	1434830000	200	17.8
M48x2	1434550000	1448160000	1434840000	320	26.8
M64x3	1434560000	1448170000	1434850000	500	39.0

**Rod Clevis Dimensions**

Part No.	AV	CE	CK Ø H9	CL	CM A16	CR	ER	KK Thread	LE	Weight kg
1434470000	17	32	10	25	12	20	12	M10x1.25	14	0.08
1434480000	16	36	12	32	16	32	17	M12x1.25	19	0.25
1434490000	18	38	14	40	20	30	17	M14x1.5	19	0.32
1434500000	22	54	20	60	30	50	29	M16x1.5	32	1.0
1434510000	28	60	20	60	30	50	29	M20x1.5	32	1.1
1434520000	36	75	28	83	40	61	34	M27x2	39	2.3
1434530000	45	99	36	103	50	76	50	M33x2	54	2.6
1434540000	56	113	45	123	60	102	53	M42x2	57	5.5
1434550000	63	126	56	143	70	112	59	M48x2	63	7.6
1434560000	85	168	70	163	80	146	78	M64x3	83	13.0

**Rod Clevis**

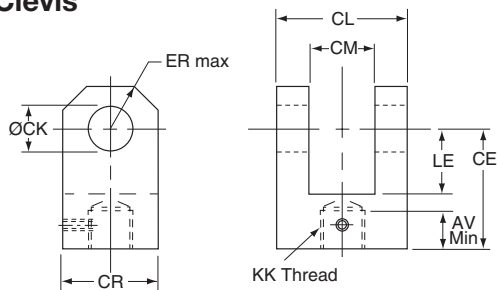

**Pivot Pin for Clevis Bracket and Plain Rod Eye – Dimensions**

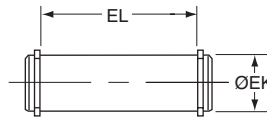

Part No.	EK Ø f8	EL	Weight kg
1434770000	10	29	0.02
1434780000	12	37	0.05
1434790000	14	45	0.08
1434800000	20	66	0.2
1434810000	28	87	0.4
1434820000	36	107	1.0
1434830000	45	129	1.8
1434840000	56	149	4.2
1434850000	70	169	6.0

**Eye Bracket – for Cap Clevis Mount**

Bore Ø	Eye Bracket	Nominal Force kN	Weight kg
25	1448080000	8	0.2
32	1448090000	12.5	0.3
40	1448100000	20	0.4
50	1448110000	32	1.0
63	1448120000	50	1.4
80	1448130000	80	3.2
100	1448140000	125	5.6
125	1448150000	200	10.5
160	1448160000	320	15.0
200	1448170000	500	20.0

**Eye Bracket Dimensions**

Part No.	CK Ø H9	EM h13	FL	MR max	LE min	AA Ø	HB Ø	TG	UD
1448080000	10	12	23	12	13	40	5.5	28.3	40
1448090000	12	16	29	17	19	47	6.6	33.2	45
1448100000	14	20	29	17	19	59	9	41.7	65
1448110000	20	30	48	29	32	74	13.5	52.3	75
1448120000	20	30	48	29	32	91	13.5	64.3	90
1448130000	28	40	59	34	39	117	17.5	82.7	115
1448140000	36	50	79	50	54	137	17.5	96.9	130
1448150000	45	60	87	53	57	178	26	125.9	165
1448160000	56	70	103	59	63	219	30	154.9	205
1448170000	70	80	132	78	82	269	33	190.2	240

**Eye Bracket**

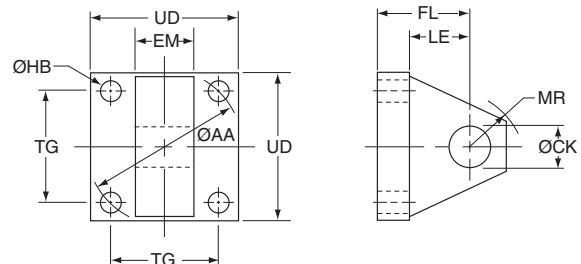

All dimensions are in millimeters unless otherwise stated.

**Plain Rod Eye, Clevis Bracket and Pivot Pin**

KK Thread	Plain Rod Eye	Clevis Bracket	Pivot Pin	Nominal Force kN	Weight kg
M10x1.25	1434570000	1436460000	1434770000	8	0.5
M12x1.25	1434580000	1436470000	1434780000	12.5	1.0
M14x1.5	1434590000	1436480000	1434790000	20	1.3
M16x1.5	1434600000	1436490000	1434800000	32	3.2
M20x1.5	1434610000	1436490000	1434800000	50	3.8
M27x2	1434620000	1436500000	1434810000	80	6.9
M33x2	1434630000	1436510000	1434820000	125	12.5
M42x2	1434640000	1436520000	1434830000	200	26.0
M48x2	1434650000	1436530000	1434840000	320	47.0
M64x3	1434660000	1436540000	1434850000	500	64.0

**Plain Rod Eye / Knuckle Dimensions**

Part No.	AW	CA	CB	CD	CK Ø H9	EM h13	ER	KK Thread	LE	Weight kg
1434570000	14	32	18	9	10	12	12	M10x1.25	13	0.08
1434580000	16	36	22	11	12	16	17	M12x1.25	19	0.15
1434590000	18	38	20	12.5	14	20	17	M14x1.5	19	0.22
1434600000	22	54	30	17.5	20	30	29	M16x1.5	32	0.5
1434610000	28	60	30	20	20	30	29	M20x1.5	32	1.1
1434620000	36	75	40	25	28	40	34	M27x2	39	1.5
1434630000	45	99	50	35	36	50	50	M33x2	54	2.5
1434640000	56	113	65	50	45	60	53	M42x2	57	4.2
1434650000	63	126	90	56	56	70	59	M48x2	63	11.8
1434660000	85	168	110	70	70	80	78	M64x3	83	17.0

**Plain Rod Eye / Knuckle**

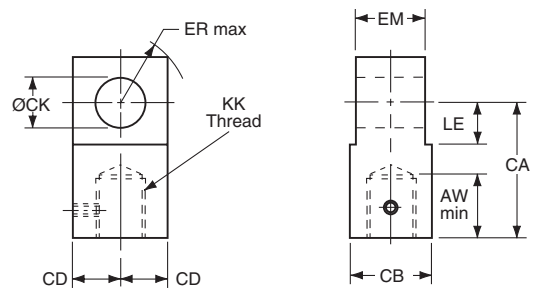

**Clevis Bracket Dimensions**

Part No.	CK Ø H9	CM A16	CW	FL	MR max	HB	LE min	RC	TB	UR	UH
1436460000	10	12	6	23	12	5.5	13	18	47	35	60
1436470000	12	16	8	29	17	6.6	19	24	57	45	70
1436480000	14	20	10	29	17	9	19	30	68	55	85
1436490000	20	30	15	48	29	13.5	32	45	102	80	125
1436500000	28	40	20	59	34	17.5	39	60	135	100	170
1436510000	36	50	25	79	50	17.5	54	75	167	130	200
1436520000	45	60	30	87	53	26	57	90	183	150	230
1436530000	56	70	35	103	59	30	63	105	242	180	300
1436540000	70	80	40	132	78	33	82	120	300	200	360

**Clevis Bracket**

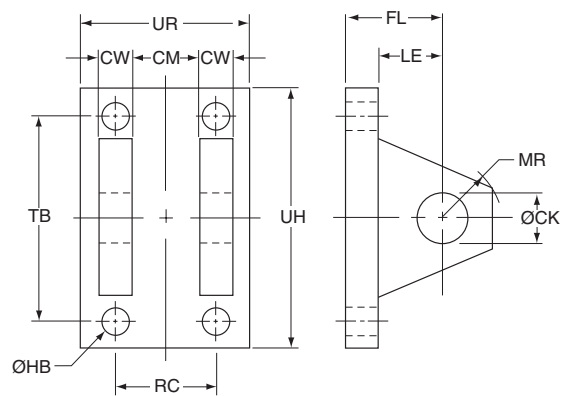

**Clevis Bracket – for Cap Eye Mount**

Bore Ø	Part No.	Nominal Force kN	Weight kg
25	1436460000	8	0.4
32	1436470000	12.5	0.8
40	1436480000	20	1.0
50	1436490000	32	2.5
63	1436490000	50	2.5
80	1436500000	80	5.0
100	1436510000	125	9.0
125	1436520000	200	20.0
160	1436530000	320	31.0
200	1436540000	500	41.0

**Pivot Pin for Clevis Bracket and Plain Rod Eye – Dimensions**



All dimensions are in millimeters unless otherwise stated.

Part No.	EK Ø f8	EL	Weight kg
1434770000	10	29	0.02
1434780000	12	37	0.05
1434790000	14	45	0.08
1434800000	20	66	0.2
1434810000	28	87	0.4
1434820000	36	107	1.0
1434830000	45	129	1.8
1434840000	56	149	4.2
1434850000	70	169	6.0

**Rod Eye with Spherical Bearing, Mounting Bracket and Pivot Pin**

KK Thread	Rod Eye with Spherical Bearing	Mounting Bracket and Pivot Pin	Nominal Force kN	Weight kg
M10x1.25	1452540000	1455300000	8	0.2
M12x1.25	1452550000	1455310000	12.5	0.3
M14x1.5	1452560000	1455320000	20	0.4
M16x1.5	1452570000	1455330000	32	0.7
M20x1.5	1452580000	1455340000	50	1.3
M27x2	1452590000	1455350000	80	2.3
M33x2	1452600000	1455360000	125	4.4
M42x2	1452610000	1455370000	200	8.4
M48x2	1452620000	1455380000	320	15.6
M64x3	1452630000	1455390000	500	28.0

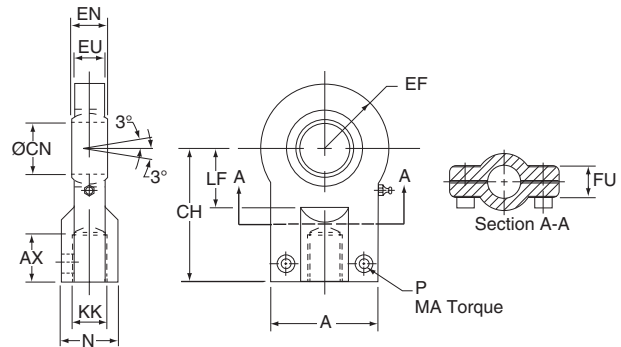

**Rod Eye with Spherical Bearing**

All spherical bearings should be re-packed with grease when servicing. In unusual or severe working conditions, consult the factory regarding the suitability of the bearing chosen.

**Rod Eye with Spherical Bearing Dimensions**

Part No.	A max	AX min	EF max	CH	CN Ø	EN	EU	FU	KK Thread	LF min	N max	MA max Nm	P
1452540000	40	15	20	42	12 -0.008	10 -.012	8	13	M10x1.25	16	17	10	M6
1452550000	45	17	22.5	48	16 -0.008	14 -.012	11	13	M12x1.25	20	21	10	M6
1452560000	55	19	27.5	58	20 -0.012	16 -.012	13	17	M14x1.5	25	25	25	M8
1452570000	62	23	32.5	68	25 -0.012	20 -.012	17	17	M16x1.5	30	30	25	M8
1452580000	80	29	40	85	30 -0.012	22 -.012	19	19	M20x1.5	35	36	45	M10
1452590000	90	37	50	105	40 -0.012	28 -.012	23	23	M27x2	45	45	45	M10
1452600000	105	46	62.5	130	50 -0.012	35 -.012	30	30	M33x2	58	55	80	M12
1452610000	134	57	80	150	60 -0.015	44 -.015	38	38	M42x2	68	68	160	M16
1452620000	156	64	102.5	185	80 -0.015	55 -.015	47	47	M48x2	92	90	310	M20
1452630000	190	86	120	240	100 -0.020	70 -.020	57	57	M64x3	116	110	530	M24

**Mounting Bracket and Pivot Pin Dimensions**

Part No.	CF Ø K7/h6	CG +0.1, +0.3	CO N9	CP	FM js11	FO js14	GL js13	HB Ø	KC 0, +0.30	LG	LJ	LO	RE js13	SR max	TA js13	UJ	UK
1455300000	12	10	10	30	40	16	46	9	3.3	28	29	56	55	12	40	75	60
1455310000	16	14	16	40	50	18	61	11	4.3	37	38	74	70	16	55	95	80
1455320000	20	16	16	50	55	20	64	14	4.3	39	40	80	85	20	58	120	90
1455330000	25	20	25	60	65	22	78	16	5.4	48	49	98	100	25	70	140	110
1455340000	30	22	25	70	85	24	97	18	5.4	62	63	120	115	30	90	160	135
1455350000	40	28	36	80	100	24	123	22	8.4	72	73	148	135	40	120	190	170
1455360000	50	35	36	100	125	35	155	30	8.4	90	92	190	170	50	145	240	215
1455370000	60	44	50	120	150	35	187	39	11.4	108	110	225	200	60	185	270	260
1455380000	80	55	50	160	190	35	255	45	11.4	140	142	295	240	80	260	320	340
1455390000	100	70	63	200	210	35	285	48	12.4	150	152	335	300	100	300	400	400

**Cap Mounting Bracket and Pivot Pin**

Bore Ø	Mounting Bracket and Pivot Pin	Nominal Force kN	Weight kg
25	1455300000	8	0.6
32	1455310000	12.5	1.3
40	1455320000	20	2.1
50	1455330000	32	3.2
63	1455340000	50	6.5
80	1455350000	80	12.0
100	1455360000	125	23.0
125	1455370000	200	37.0
160	1455380000	320	79.0
200	1455390000	500	140.0

**Mounting Bracket and Pivot Pin**

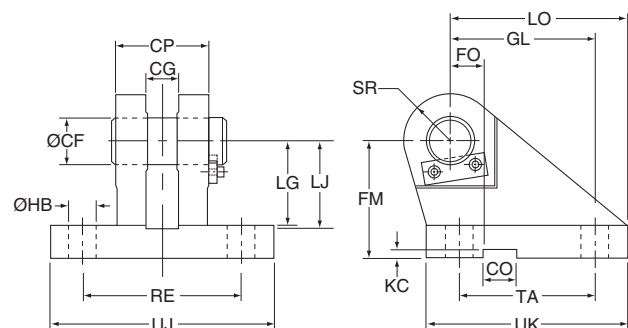

All dimensions are in millimeters unless otherwise stated.

**Cylinder Accessories**

Type 316 Stainless Steel mounting accessories are offered to provide you a complete corrosion resistant cylinder mounting package.

Accessories offered include Rod Clevis, Rod Eye, Eye Bracket, Clevis Bracket and (17-4 SS) Pivot Pin. To select the proper part number for any desired accessory, refer to the table below and look in the row to the right of the rod thread in the first column. The Pivot Pins, Eye Brackets and Clevis Brackets are listed opposite the pin diameter that fits their mating Rod Eyes or Clevises.

**Accessory Load Capacity**

The various accessories have been load rated for your convenience. The load capacity, shown in the tables below, is the recommended maximum load for that accessory based on a 4:1 design factor in tension. (Pivot pin is rated in shear). Before specifying, compare the actual load or the tension (pull) force at maximum operating pressure of the cylinder with the load capacity of the accessory you plan to use. If the load or pull force of the cylinder exceeds the accessory capacity, consult the factory.

**All Stainless Steel Accessories Include Electropolishing**

**Rod End Accessories**

Thread Size	Pin Ø	Rod Clevis		Eye Bracket		Pivot Pin	
		Part Number	Load Capacity (lb)	Part Number	Load Capacity (lb)	Part Number	Load Capacity (lb)
7/16-20	0.500	0938480000	2125	0938680000	2050	0938820000	8000
1/2-20	0.500	0938490000	2450	0938680000	2050	0938820000	8000
3/4-16	0.750	0938500000	5600	0938690000	5800	0938830000	17900
7/8-14	1.000	0938510000	9400	0938700000	12200	0938840000	31900
1-14	1.000	0938520000	9750	0938700000	12200	0938840000	31900
1 1/4-12	1.375	0938530000	22300	0938710000	12720	0938850000	60500
1 1/2-12	1.750	0938540000	30400	0938720000	32900	0938860000	98000
1 3/4-12	2.000	0938550000	43700	0938730000	46600	0938870000	127700
1 7/8-12	2.000	0938560000	43700	0938730000	46600	0938870000	127700
2 1/4-12	2.500	0938570000	65400	0938740000	62800	0938880000	199600

**Rod End Accessories**

Thread Size	Pin Ø	Knuckle		Clevis Bracket		Pivot Pin	
		Part Number	Load Capacity (lb)	Part Number	Load Capacity (lb)	Part Number	Load Capacity (lb)
7/16-20	0.500	0938580000	2700	0938750000	3650	0938820000	8000
1/2-20	0.500	0938590000	3100	0938750000	3650	0938820000	8000
3/4-16	0.750	0938600000	7200	0938760000	7000	0938830000	17900
7/8-14	1.000	0938610000	7800	0938770000	9600	0938840000	31900
1-14	1.000	0938620000	13000	0938770000	9600	0938840000	31900
1 1/4-12	1.375	0938630000	20000	0938780000	18850	0938850000	60500
1 1/2-12	1.750	0938640000	30000	0938790000	17100	0938860000	98000
1 3/4-12	2.000	0938650000	35500	0938800000	19700	0938870000	127700
1 7/8-12	2.000	0938660000	50000	0938800000	19700	0938870000	127700
2 1/4-12	2.500	0938670000	65000	0938810000	20900	0938880000	199600



**Rod Clevis Dimensions**

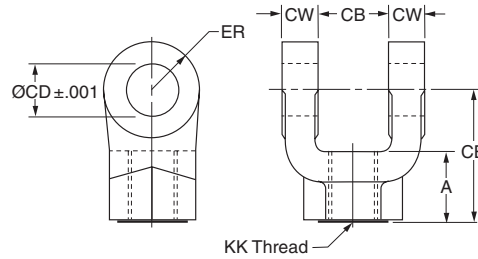

Part Number	Pin Ø	A	CB	CD Ø	CE	CW	ER	KK Thread
0938480000	0.500	0.75	0.77	0.503	1.50	0.49	0.50	7/16-20
0938490000	0.500	0.75	0.77	0.503	1.50	0.49	0.50	1/2-20
0938500000	0.750	1.13	1.27	0.753	2.38	0.62	0.75	3/4-16
0938510000	1.000	1.63	1.52	1.003	3.13	0.74	1.00	7/8-14
0938520000	1.000	1.63	1.52	1.003	3.13	0.74	1.00	1-14
0938530000	1.375	2.00	2.04	1.378	4.13	0.99	1.38	1 1/4-12
0938540000	1.750	2.25	2.54	1.753	4.50	1.24	1.75	1 1/2-12
0938550000	2.000	3.00	2.54	2.003	5.50	1.24	2.00	1 3/4-12
0938560000	2.000	3.00	2.54	2.003	5.50	1.24	2.00	1 7/8-12
0938570000	2.500	3.50	3.04	2.503	6.50	1.49	2.50	2 1/4-12

**Eye Bracket Dimensions**

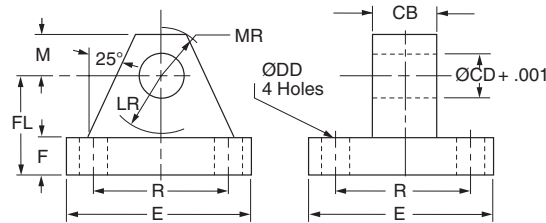

Part Number	Pin Ø	CB	CD Ø	DD Ø	E	F	FL	LR	M	MR	R
0938680000	0.500	0.75	0.503	0.41	2.50	0.38	1.13	0.75	0.50	0.56	1.63
0938690000	0.750	1.25	0.753	0.53	3.50	0.63	1.88	1.25	0.75	0.88	2.55
0938700000	1.000	1.50	1.003	0.66	4.50	0.88	2.38	1.50	1.00	1.25	3.25
0938710000	1.375	2.00	1.378	0.66	5.00	0.88	3.00	2.00	1.38	1.63	3.82
0938720000	1.750	2.50	1.753	0.91	6.50	1.13	3.38	2.25	1.75	2.13	4.95
0938730000	2.000	2.50	2.003	1.06	7.50	1.50	4.00	2.50	2.00	2.44	5.73
0938740000	2.500	3.00	2.503	1.19	8.50	1.75	4.75	3.00	2.50	3.00	6.58

**Pivot Pin Dimensions**

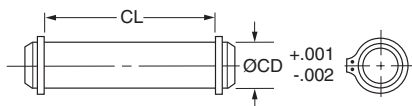

Part Number	CD Ø	CL
0938820000	0.500	1.88
0938830000	0.750	2.63
0938840000	1.000	3.13
0938850000	1.375	4.13
0938860000	1.750	5.19
0938870000	2.000	5.19
0938880000	2.500	6.19

1. Pivot Pins are furnished with (2) retainer rings.
2. Pivot Pins must be ordered as a separate item if to be used with Rod Clevises or Clevis Brackets.

**Knuckle Dimensions**

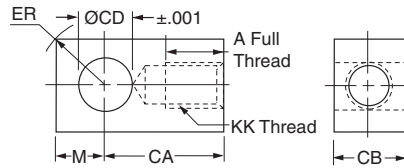

Part Number	Pin Ø	A	CA	CB	CD Ø	ER	KK Thread	M
0938580000	0.500	0.75	1.50	0.75	0.503	0.71	7/16-20	0.50
0938590000	0.500	0.75	1.50	0.75	0.503	0.71	1/2-20	0.50
0938600000	0.750	1.13	2.06	1.25	0.753	1.06	3/4-16	0.75
0938610000	1.000	1.13	2.38	1.50	1.003	1.41	7/8-14	1.00
0938620000	1.000	1.63	2.81	1.50	1.003	1.41	1-14	1.00
0938630000	1.375	2.00	3.44	2.00	1.378	1.94	1 1/4-12	1.38
0938640000	1.750	2.25	4.00	2.50	1.753	2.47	1 1/2-12	1.75
0938650000	2.000	2.25	4.38	2.50	2.003	2.83	1 3/4-12	2.00
0938660000	2.000	3.00	5.00	2.50	2.003	2.83	1 7/8-12	2.00
0938670000	2.500	3.50	5.81	3.00	2.503	3.54	2 1/4-12	2.50

**Clevis Bracket Dimensions**

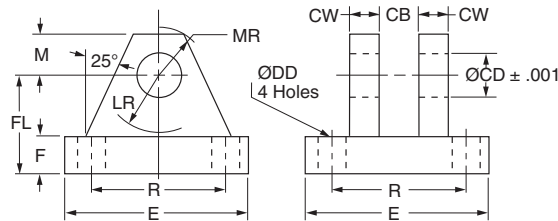

Part Number	Pin Ø	CB	CD Ø	CW	DD Ø	E	F	FL	LR	M	MR	R
0938750000	0.500	0.78	0.503	0.50	0.41	3.50	0.50	1.50	0.75	0.50	0.63	2.55
0938760000	0.750	1.30	0.753	0.63	0.53	5.00	0.63	1.88	1.19	0.75	0.91	3.82
0938770000	1.000	1.59	1.003	0.75	0.66	6.50	0.75	2.25	1.50	1.00	1.25	4.95
0938780000	1.375	2.09	1.378	1.00	0.66	7.50	0.88	3.00	2.00	1.38	1.66	5.73
0938790000	1.750	2.56	1.753	1.25	0.91	9.50	0.88	3.63	2.75	1.75	2.22	7.50
0938800000	2.000	2.56	2.003	1.50	1.06	12.75	1.00	4.25	3.19	2.25	2.78	9.40
0938810000	2.500	3.06	2.503	1.50	1.19	12.75	1.00	4.50	3.50	2.50	3.13	9.40

**Pivot Pin Dimensions**

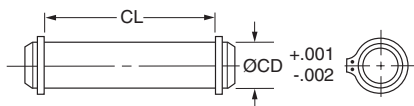

Part Number	CD Ø	CL
0938820000	0.500	1.88
0938830000	0.750	2.63
0938840000	1.000	3.13
0938850000	1.375	4.13
0938860000	1.750	5.19
0938870000	2.000	5.19
0938880000	2.500	6.19

1. Pivot Pins are furnished with (2) retainer rings.
2. Pivot Pins must be ordered as a separate item if to be used with Rod Clevises or Clevis Brackets.

**Manufacturing Locations****Regional Plants**

---

**California**

221 Helicopter Circle  
Corona, CA 92880  
Tel.: (951) 280-3800  
Fax: (951) 280-3808  
Fax: (800) 869-9886

---

**Connecticut**

80 Shaker Road  
Enfield, CT 06082  
Tel.: (860) 749-2215  
Fax: (800) 323-0105

---

**Georgia**

1300 Six Flags Road  
Lithia Springs, GA 30122  
Tel.: (770) 819-3400  
Fax: (800) 437-3498

---

**Indiana**

Goodland Plant  
715 South Iroquois Street  
Goodland, IN 47948  
Tel.: (219) 297-3182  
Fax: (800) 328-8120

---

**Michigan**

900 Plymouth Road  
Plymouth, MI 48170  
Tel.: (734) 455-1700  
Fax: (734) 455-1007

---

**Oregon**

29289 Airport Road  
Eugene, OR 97402-0079  
Tel.: 541-689-9111  
Fax: 541-688-6771  
Fax: 800-624-7996

---

## Safety Guide for Selecting and Using Hydraulic, Pneumatic Cylinders and Their Accessories

**WARNING:** ⚠ FAILURE OF THE CYLINDER, ITS PARTS, ITS MOUNTING, ITS CONNECTIONS TO OTHER OBJECTS, OR ITS CONTROLS CAN RESULT IN:

- Unanticipated or uncontrolled movement of the cylinder or objects connected to it.
- Falling of the cylinder or objects held up by it.
- Fluid escaping from the cylinder, potentially at high velocity.

**THESE EVENTS COULD CAUSE DEATH OR PERSONAL INJURY BY, FOR EXAMPLE, PERSONS FALLING FROM HIGH LOCATIONS, BEING CRUSHED OR STRUCK BY HEAVY OR FAST MOVING OBJECTS, BEING PUSHED INTO DANGEROUS EQUIPMENT OR SITUATIONS, OR SLIPPING ON ESCAPED FLUID.**

Before selecting or using Parker Hannifin Corporation (the Company) cylinders or related accessories, it is important that you read, understand and follow the following safety information. Training is advised before selecting and using the Company's products.

### 1.0 General Instructions

**1.1 Scope** – This safety guide provides instructions for selecting and using (including assembling, installing, and maintaining) cylinder products. This safety guide is a supplement to and is to be used with the specific Company publications for the specific cylinder products that are being considered for use.

**1.2 Fail Safe** – Cylinder products can and do fail without warning for many reasons. All systems and equipment should be designed in a fail-safe mode so that if the failure of a cylinder product occurs people and property won't be endangered.

**1.3 Distribution** – Provide a free copy of this safety guide to each person responsible for selecting or using cylinder products. Do not select or use the Company's cylinders without thoroughly reading and understanding this safety guide as well as the specific Company publications for the products considered or selected.

**1.4 User Responsibility** – Due to very wide variety of cylinder applications and cylinder operating conditions, the Company does not warrant that any particular cylinder is suitable for any specific application. This safety guide does not analyze all technical parameters that must be considered in selecting a product. The hydraulic and pneumatic cylinders outlined in this catalog are designed to the Company's design guidelines and do not necessarily meet the design guideline of other agencies such as American Bureau of Shipping, ASME Pressure Vessel Code etc. The user, through its own analysis and testing, is solely responsible for:

- Making the final selection of the cylinders and related accessories.
- Determining if the cylinders are required to meet specific design requirements as required by the Agency(s) or industry standards covering the design of the user's equipment.
- Assuring that the user's requirements are met, OSHA requirements are met, and safety guidelines from the applicable agencies such as but not limited to ANSI are followed and that the use presents no health or safety hazards.
- Providing all appropriate health and safety warnings on the equipment on which the cylinders are used.

**1.5 Additional Questions** – Call the appropriate Company technical service department if you have any questions or require any additional information. See the Company publication for the product being considered or used, or call 1-847-298-2400, or go to [www.parker.com](http://www.parker.com), for telephone numbers of the appropriate technical service department.

### 2.0 Cylinder and Accessories Selection

**2.1 Seals** – Part of the process of selecting a cylinder is the selection of seal compounds. Before making this selection, consult the "seal information page(s)" of the publication for the series of cylinders of interest.

The application of cylinders may allow fluids such as cutting fluids, wash down fluids etc. to come in contact with the external area of the cylinder. These fluids may attack the piston rod wiper and or the primary seal and must be taken into account when selecting and specifying seal compounds.

Dynamic seals will wear. The rate of wear will depend on many operating factors. Wear can be rapid if a cylinder is mis-aligned or if the cylinder has been improperly serviced. The user must take seal wear into consideration in the application of cylinders.

**2.2 Piston Rods** – Possible consequences of piston rod failure or separation of the piston rod from the piston include, but are not limited to are:

- Piston rod and or attached load thrown off at high speed.
- High velocity fluid discharge.
- Piston rod extending when pressure is applied in the piston retract mode.

Piston rods or machine members attached to the piston rod may move suddenly and without warning as a consequence of other conditions occurring to the machine such as, but not limited to:

- Unexpected detachment of the machine member from the piston rod.

- Failure of the pressurized fluid delivery system (hoses, fittings, valves, pumps, compressors) which maintain cylinder position.
- Catastrophic cylinder seal failure leading to sudden loss of pressurized fluid.
- Failure of the machine control system.

Follow the recommendations of the "Piston Rod Selection Chart and Data" in the publication for the series of cylinders of interest. The suggested piston rod diameter in these charts must be followed in order to avoid piston rod buckling.

Piston rods are not normally designed to absorb bending moments or loads which are perpendicular to the axis of piston rod motion. These additional loads can cause the piston rod to fail. If these types of additional loads are expected to be imposed on the piston rod, their magnitude should be made known to our engineering department.

The cylinder user should always make sure that the piston rod is securely attached to the machine member.

On occasion cylinders are ordered with double rods (a piston rod extended from both ends of the cylinder). In some cases a stop is threaded on to one of the piston rods and used as an external stroke adjuster. On occasions spacers are attached to the machine member connected to the piston rod and also used as a stroke adjuster. In both cases the stops will create a pinch point and the user should consider appropriate use of guards. If these external stops are not perpendicular to the mating contact surface, or if debris is trapped between the contact surfaces, a bending moment will be placed on the piston rod, which can lead to piston rod failure. An external stop will also negate the effect of cushioning and will subject the piston rod to impact loading. Those two (2) conditions can cause piston rod failure. Internal stroke adjusters are available with and without cushions. The use of external stroke adjusters should be reviewed with our engineering department.

The piston rod to piston and the stud to piston rod threaded connections are secured with an anaerobic adhesive. The strength of the adhesive decreases with increasing temperature. Cylinders which can be exposed to temperatures above +250°F (+121°C) are to be ordered with a non studded piston rod and a pinned piston rod joint.

**2.3 Cushions** – Cushions should be considered for cylinder applications when the piston velocity is expected to be over 4 inches/second.

Cylinder cushions are normally designed to absorb the energy of a linear applied load. A rotating mass has considerably more energy than the same mass moving in a linear mode. Cushioning for a rotating mass application should be reviewed by our engineering department.

**2.4 Cylinder Mountings** – Some cylinder mounting configurations may have certain limitations such as but not limited to minimum stroke for side or foot mounting cylinders or pressure de-ratings for certain mounts. Carefully review the catalog for these types of restrictions.

Always mount cylinders using the largest possible high tensile alloy steel socket head cap screws that can fit in the cylinder mounting holes and torque them to the manufacturer's recommendations for their size.

**2.5 Port Fittings** – Hydraulic cylinders applied with meter out or deceleration circuits are subject to intensified pressure at piston rod end.

The rod end pressure is approximately equal to:

$$\frac{\text{operating pressure} \times \text{effective cap end area}}{\text{effective rod end piston area}}$$

Contact your connector supplier for the pressure rating of individual connectors.

### 3.0 Cylinder and Accessories Installation and Mounting

#### 3.1 Installation

**3.1.1** – Cleanliness is an important consideration, and cylinders are shipped with the ports plugged to protect them from contaminants entering the ports. These plugs should not be removed until the piping is to be installed. Before making the connection to the cylinder ports, piping should be thoroughly cleaned to remove all chips or burrs which might have resulted from threading or flaring operations.

**3.1.2** – Cylinders operating in an environment where air drying materials are present such as fast-drying chemicals, paint, or weld splatter, or other hazardous conditions such as excessive heat, should have shields installed to prevent damage to the piston rod and piston rod seals.

**3.1.3** – Proper alignment of the cylinder piston rod and its mating component on the machine should be checked in both the extended and retracted positions. Improper alignment will result in excessive rod gland and/or cylinder bore wear. On fixed mounting cylinders attaching the piston rod while the rod is retracted will help in achieving proper alignment.

**3.1.4** – Sometimes it may be necessary to rotate the piston rod in order to thread the piston rod into the machine member. This operation must always be done with zero pressure being applied to either side of the piston. Failure to follow this procedure may result in loosening the piston to rod-threaded connection. In some rare cases the turning of the piston rod may rotate a threaded head and loosen it from the cylinder body. Confirm that this condition is not occurring. If it does, re-tighten the head firmly against the cylinder body.

For double rod cylinders it is also important that when attaching or detaching the piston rod from the machine member that the torque be applied to the piston rod end of the cylinder that is directly attaching to the machine member with the opposite end unrestrained. If the design of the machine is such that only the rod end of the cylinder opposite to where the rod attaches to the machine member can be rotated, consult the factory for further instructions.

### 3.2 Mounting Recommendations

**3.2.1** – Always mount cylinders using the largest possible high tensile alloy steel socket head screws that can fit in the cylinder mounting holes and torque them to the manufacturer's recommendations for their size.

**3.2.2** – Side-Mounted Cylinders – In addition to the mounting bolts, cylinders of this type should be equipped with thrust keys or dowel pins located so as to resist the major load.

**3.2.3** – Tie Rod Mounting – Cylinders with tie rod mountings are recommended for applications where mounting space is limited. Nuts used for this mounting style should be torqued to the same value as the tie rods for that bore size.

**3.2.4** – Flange Mount Cylinders – The controlled diameter of the rod gland extension on head end flange mount cylinders can be used as a pilot to locate the cylinders in relation to the machine. After alignment has been obtained, the flanges may be drilled for pins or dowels to prevent shifting.

**3.2.5** – Trunnion Mountings – Cylinders require lubricated bearing blocks with minimum bearing clearances. Bearing blocks should be carefully aligned and rigidly mounted so the trunnions will not be subjected to bending moments. The rod end should also be pivoted with the pivot pin in line and parallel to axis of the trunnion pins.

**3.2.6** – Clevis Mountings – Cylinders should be pivoted at both ends with centerline of pins parallel to each other. After cylinder is mounted, be sure to check to assure that the cylinder is free to swing through its working arc without interference from other machine parts.

### 4.0 Cylinder and Accessories Maintenance, Troubleshooting and Replacement

**4.1 Storage** – At times cylinders are delivered before a customer is ready to install them and must be stored for a period of time. When storage is required the following procedures are recommended.

**4.1.1** – Store the cylinders in an indoor area which has a dry, clean and noncorrosive atmosphere. Take care to protect the cylinder from both internal corrosion and external damage.

**4.1.2** – Whenever possible cylinders should be stored in a vertical position (piston rod up). This will minimize corrosion due to possible condensation which could occur inside the cylinder. This will also minimize seal damage.

**4.1.3** – Port protector plugs should be left in the cylinder until the time of installation.

**4.1.4** – If a cylinder is stored full of hydraulic fluid, expansion of the fluid due to temperature changes must be considered. Installing a check valve with free flow out of the cylinder is one method.

**4.1.5** – When cylinders are mounted on equipment that is stored outside for extended periods, exposed unpainted surfaces, e.g. piston rod, must be coated with a rust-inhibiting compound to prevent corrosion.

### 4.2 Cylinder Trouble Shooting

#### 4.2.1 – External Leakage

**4.2.1.1** – Rod seal leakage can generally be traced to worn or damaged seals. Examine the piston rod for dents, gouges or score marks, and replace piston rod if surface is rough.

Rod seal leakage could also be traced to bearing wear. If clearance is excessive, replace rod bearing and seal. Rod seal leakage can also be traced to seal deterioration. If seals are soft or gummy or brittle, check compatibility of seal material with lubricant used if air cylinder, or operating fluid if hydraulic cylinder. Replace with seal material, which is compatible with these fluids. If the seals are hard or have lost elasticity, it is usually due to exposure to temperatures in excess of 165°F. (+74°C). Shield the cylinder from the heat source to limit temperature to 350°F. (+177°C.) and replace with fluorocarbon seals.

**4.2.1.2** – Cylinder body seal leak can generally be traced to a loose head. Torque the head to manufacturer's recommendation for that bore size.

Excessive pressure can also result in cylinder body seal leak. Determine maximum pressure to rated limits. Replace seals and retorque head as in paragraph above. Excessive pressure can also result in cylinder body seal leak. Determine if the pressure rating of the cylinder has been exceeded. If so, bring the operating pressure down to the rating of the cylinder and have the head replaced.

Pinched or extruded cylinder body seal will also result in a leak. Replace cylinder body seal and retorque as in paragraph above.

Cylinder body seal leakage due to loss of radial squeeze which shows up in the form of flat spots or due to wear on the O.D. or I.D. – Either of these are symptoms of normal wear due to high cycle rate or length of service. Replace seals as per paragraph above.

#### 4.2.2 – Internal Leakage

**4.2.2.1** – Piston seal leak (by-pass) 1 to 3 cubic inches per minute leakage is considered normal for piston ring construction. Virtually no static leak with lipseal type seals on piston should be expected. Piston seal wear is a usual cause of piston seal leakage. Replace seals as required.

**4.2.2.2** – With lipseal type piston seals excessive back pressure due to over-adjustment of speed control valves could be a direct cause of rapid seal wear. Contamination in a hydraulic system can result in a scored cylinder bore, resulting in rapid seal wear. In either case, replace piston seals as required.

**4.2.2.3** – What appears to be piston seal leak, evidenced by the fact that the cylinder drifts, is not always traceable to the piston. To make sure, it is suggested that one side of the cylinder piston be pressurized and the fluid line at the opposite port be disconnected. Observe leakage. If none is evident, seek the cause of cylinder drift in other component parts in the circuit.

#### 4.2.3 – Cylinder Fails to Move the Load

**4.2.3.1** – Pneumatic or hydraulic pressure is too low. Check the pressure at the cylinder to make sure it is to circuit requirements.

**4.2.3.2** – Piston Seal Leak – Operate the valve to cycle the cylinder and observe fluid flow at valve exhaust ports at end of cylinder stroke. Replace piston seals if flow is excessive.

**4.2.3.3** – Cylinder is undersized for the load – Replace cylinder with one of a larger bore size.

#### 4.3 Erratic or Chatter Operation

**4.3.1** – Excessive friction at rod bearing or piston bearing due to load misalignment – Correct cylinder-to-load alignment.

**4.3.2** – Cylinder sized too close to load requirements – Reduce load or install larger cylinder.

**4.3.3** – Erratic operation could be traced to the difference between static and kinetic friction. Install speed control valves to provide a back pressure to control the stroke.

**4.4 Cylinder Modifications, Repairs, or Failed Component** – Cylinders as shipped from the factory are not to be disassembled and/or modified. If cylinders require modifications, these modifications must be done at company locations or by the Company's certified facilities. The Industrial Cylinder Division Engineering Department must be notified in the event of a mechanical fracture or permanent deformation of any cylinder component (excluding seals). This includes a broken piston rod, head, mounting accessory or any other cylinder component. The notification should include all operation and application details. This information will be used to provide an engineered repair that will prevent recurrence of the failure.

It is allowed to disassemble cylinders for the purpose of replacing seals or seal assemblies. However, this work must be done by strictly following all the instructions provided with the seal kits.

## Offer of Sale

The items described in this document and other documents and descriptions provided by Parker Hannifin Corporation, its subsidiaries and its authorized distributors ("Seller") are hereby offered for sale at prices to be established by Seller. This offer and its acceptance by any customer ("Buyer") shall be governed by all of the following Terms and Conditions. Buyer's order for any item described in its document, when communicated to Seller verbally, or in writing, shall constitute acceptance of this offer. All goods, services or work described will be referred to as "Products".

**1. Terms and Conditions.** Seller's willingness to offer Products, or accept an order for Products, to or from Buyer is subject to these Terms and Conditions or any newer version of the terms and conditions found on-line at [www.parker.com/saleterms/](http://www.parker.com/saleterms/). Seller objects to any contrary or additional terms or conditions of Buyer's order or any other document issued by Buyer.

**2. Price Adjustments; Payments.** Prices stated on Seller's quote or other documentation offered by Seller are valid for 30 days, and do not include any sales, use, or other taxes unless specifically stated. Unless otherwise specified by Seller, all prices are F.C.A. Seller's facility (INCOTERMS 2010). Payment is subject to credit approval and is due 30 days from the date of invoice or such other term as required by Seller's Credit Department, after which Buyer shall pay interest on any unpaid invoices at the rate of 1.5% per month or the maximum allowable rate under applicable law.

**3. Delivery Dates; Title and Risk; Shipment.** All delivery dates are approximate and Seller shall not be responsible for any damages resulting from any delay. Regardless of the manner of shipment, title to any products and risk of loss or damage shall pass to Buyer upon placement of the products with the shipment carrier at Seller's facility. Unless otherwise stated, Seller may exercise its judgment in choosing the carrier and means of delivery. No deferment of shipment at Buyers' request beyond the respective dates indicated will be made except on terms that will indemnify, defend and hold Seller harmless against all loss and additional expense. Buyer shall be responsible for any additional shipping charges incurred by Seller due to Buyer's acts or omissions.

**4. Warranty.** Seller warrants that the Products sold hereunder shall be free from defects in material or workmanship for a period of eighteen months from the date of delivery to Buyer. The prices charged for Seller's products are based upon the exclusive limited warranty stated above, and upon the following disclaimer: **DISCLAIMER OF WARRANTY: THIS WARRANTY COMPRISES THE SOLE AND ENTIRE WARRANTY PERTAINING TO PRODUCTS PROVIDED HEREUNDER. SELLER DISCLAIMS ALL OTHER WARRANTIES, EXPRESS AND IMPLIED, INCLUDING DESIGN, MERCHANTABILITY AND FITNESS FOR A PARTICULAR PURPOSE.**

**5. Claims; Commencement of Actions.** Buyer shall promptly inspect all Products upon delivery. No claims for shortages will be allowed unless reported to the Seller within 10 days of delivery. No other claims against Seller will be allowed unless asserted in writing within 30 days after delivery. Buyer shall notify Seller of any alleged breach of warranty within 30 days after the date the defect is or should have been discovered by Buyer. Any action based upon breach of this agreement or upon any other claim arising out of this sale (other than an action by Seller for an amount due on any invoice) must be commenced within 12 months from the date of the breach without regard to the date breach is discovered.

**6. LIMITATION OF LIABILITY.** UPON NOTIFICATION, SELLER WILL, AT ITS OPTION, REPAIR OR REPLACE A DEFECTIVE PRODUCT, OR REFUND THE PURCHASE PRICE. **IN NO EVENT SHALL SELLER BE LIABLE TO BUYER FOR ANY SPECIAL, INDIRECT, INCIDENTAL OR CONSEQUENTIAL DAMAGES ARISING OUT OF, OR AS THE RESULT OF, THE SALE, DELIVERY, NON-DELIVERY, SERVICING, USE OR LOSS OF USE OF THE PRODUCTS OR ANY PART THEREOF, OR FOR ANY CHARGES OR EXPENSES OF ANY NATURE INCURRED WITHOUT SELLER'S WRITTEN CONSENT, EVEN IF SELLER HAS BEEN NEGLIGENT, WHETHER IN CONTRACT, TORT OR OTHER LEGAL THEORY. IN NO EVENT SHALL SELLER'S LIABILITY UNDER ANY CLAIM MADE BY BUYER EXCEED THE PURCHASE PRICE OF THE PRODUCTS.**

**7. User Responsibility.** The user, through its own analysis and testing, is solely responsible for making the final selection of the system and Product and assuring that all performance, endurance, maintenance, safety and warning requirements of the application are met. The user must analyze all aspects of the application and follow applicable industry standards and Product information. If Seller provides Product or system options, the user is responsible for determining that such data and specifications are suitable and sufficient for all applications and reasonably foreseeable uses of the Products or systems.

**8. Loss to Buyer's Property.** Any designs, tools, patterns, materials, drawings, confidential information or equipment furnished by Buyer or any other items which become Buyer's property, will be considered obsolete and may be destroyed by Seller after two consecutive years have elapsed without Buyer ordering the items manufactured using such property. Seller shall not be responsible for any loss or damage to such property while it is in Seller's possession or control.

**9. Special Tooling.** A tooling charge may be imposed for any special tooling, including without limitation, dies, fixtures, molds and patterns, acquired to manufacture Products. Such special tooling shall be and remain Seller's property notwithstanding payment of any charges by Buyer. In no event will Buyer acquire any interest in apparatus belonging to Seller which is utilized in the manufacture of the Products, even if such apparatus has been specially converted or adapted for such manufacture and notwithstanding any charges paid by Buyer. Unless otherwise agreed, Seller shall have the right to alter, discard or otherwise dispose of any special tooling or other property in its sole discretion at any time.

**10. Buyer's Obligation; Rights of Seller.** To secure payment of all sums due or otherwise, Seller shall retain a security interest in the goods delivered and this agreement shall be deemed a Security Agreement under the Uniform Commercial Code. Buyer authorizes Seller as its attorney to execute and file on Buyer's behalf all documents Seller deems necessary to perfect its security interest.

**11. Improper use and Indemnity.** Buyer shall indemnify, defend, and hold Seller harmless from any claim, liability, damages, lawsuits, and costs (including attorney fees), whether for personal injury, property damage, patent, trademark or copyright

infringement or any other claim, brought by or incurred by Buyer, Buyer's employees, or any other person, arising out of: (a) improper selection, improper application or other misuse of Products purchased by Buyer from Seller; (b) any act or omission, negligent or otherwise, of Buyer; (c) Seller's use of patterns, plans, drawings, or specifications furnished by Buyer to manufacture Product; or (d) Buyer's failure to comply with these terms and conditions. Seller shall not indemnify Buyer under any circumstance except as otherwise provided.

**12. Cancellations and Changes.** Orders shall not be subject to cancellation or change by Buyer for any reason, except with Seller's written consent and upon terms that will indemnify, defend and hold Seller harmless against all direct, incidental and consequential loss or damage. Seller may change product features, specifications, designs and availability with notice to Buyer.

**13. Limitation on Assignment.** Buyer may not assign its rights or obligations under this agreement without the prior written consent of Seller.

**14. Force Majeure.** Seller does not assume the risk and shall not be liable for delay or failure to perform any of Seller's obligations by reason of circumstances beyond the reasonable control of Seller (hereinafter "Events of Force Majeure"). Events of Force Majeure shall include without limitation: accidents, strikes or labor disputes, acts of any government or government agency, acts of nature, delays or failures in delivery from carriers or suppliers, shortages of materials, or any other cause beyond Seller's reasonable control.

**15. Waiver and Severability.** Failure to enforce any provision of this agreement will not waive that provision nor will any such failure prejudice Seller's right to enforce that provision in the future. Invalidation of any provision of this agreement by legislation or other rule of law shall not invalidate any other provision herein. The remaining provisions of this agreement will remain in full force and effect.

**16. Termination.** Seller may terminate this agreement for any reason and at any time by giving Buyer thirty (30) days written notice of termination. Seller may immediately terminate this agreement, in writing, if Buyer: (a) commits a breach of any provision of this agreement (b) appoints a trustee, receiver or custodian for all or any part of Buyer's property (c) files a petition for relief in bankruptcy on its own behalf, or by a third party (d) makes an assignment for the benefit of creditors, or (e) dissolves or liquidates all or a majority of its assets.

**17. Governing Law.** This agreement and the sale and delivery of all Products hereunder shall be deemed to have taken place in and shall be governed and construed in accordance with the laws of the State of Ohio, as applicable to contracts executed and wholly performed therein and without regard to conflicts of laws principles. Buyer irrevocably agrees and consents to the exclusive jurisdiction and venue of the courts of Cuyahoga County, Ohio with respect to any dispute, controversy or claim arising out of or relating to this agreement.

**18. Indemnity for Infringement of Intellectual Property Rights.** Seller shall have no liability for infringement of any patents, trademarks, copyrights, trade dress, trade secrets or similar rights except as provided in this Section. Seller will defend and indemnify Buyer against allegations of infringement of U.S. patents, U.S. trademarks, copyrights, trade dress and trade secrets ("Intellectual Property Rights"). Seller will defend at its expense and will pay the cost of any settlement or damages awarded in an action brought against Buyer based on an allegation that a Product sold pursuant to this Agreement infringes the Intellectual Property Rights of a third party. Seller's obligation to defend and indemnify Buyer is contingent on Buyer notifying Seller within ten (10) days after Buyer becomes aware of such allegations of infringement, and Seller having sole control over the defense of any allegations or actions including all negotiations for settlement or compromise. If a Product is subject to a claim that it infringes the Intellectual Property Rights of a third party, Seller may, at its sole expense and option, procure for Buyer the right to continue using the Product, replace or modify the Product so as to make it noninfringing, or offer to accept return of the Product and return the purchase price less a reasonable allowance for depreciation. Notwithstanding the foregoing, Seller shall have no liability for claims of infringement based on information provided by Buyer, or directed to Products delivered hereunder for which the designs are specified in whole or part by Buyer, or infringements resulting from the modification, combination or use in a system of any Product sold hereunder. The foregoing provisions of this Section shall constitute Seller's sole and exclusive liability and Buyer's sole and exclusive remedy for infringement of Intellectual Property Rights.

**19. Entire Agreement.** This agreement contains the entire agreement between the Buyer and Seller and constitutes the final, complete and exclusive expression of the terms of sale. All prior or contemporaneous written or oral agreements or negotiations with respect to the subject matter are herein merged.

**20. Compliance with Law, U. K. Bribery Act and U.S. Foreign Corrupt Practices Act.** Buyer agrees to comply with all applicable laws and regulations, including both those of the United Kingdom and the United States of America, and of the country or countries of the Territory in which Buyer may operate, including without limitation the U. K. Bribery Act, the U.S. Foreign Corrupt Practices Act ("FCPA") and the U.S. Anti-Kickback Act (the "Anti-Kickback Act"), and agrees to indemnify and hold harmless Seller from the consequences of any violation of such provisions by Buyer, its employees or agents. Buyer acknowledges that they are familiar with the provisions of the U. K. Bribery Act, the FCPA and the Anti-Kickback Act, and certifies that Buyer will adhere to the requirements thereof. In particular, Buyer represents and agrees that Buyer shall not make any payment or give anything of value, directly or indirectly to any governmental official, any foreign political party or official thereof, any candidate for foreign political office, or any commercial entity or person, for the purpose of influencing such person to purchase products or otherwise benefit the business of Seller.

**Notes**

---

Parker Hannifin Corporation  
**Schrader Bellows**  
**Cylinder Division**  
500 South Wolf Road  
Des Plaines, IL 60016 USA  
phone (847) 298-2400  
fax (800) 892-1008  
[www.schrader-bellows.com](http://www.schrader-bellows.com)

